



Epsilon 2-10D LSCplus

Part no. 110825, 110827



Freeze-dryer

Operating Manual

Please retain for later use!

In case of inquiries, please state the following numbers:

Order number:

Serial number:

© Copyright by
Martin Christ Gefriertrocknungsanlagen GmbH
An der Unteren Söse 50
37520 Osterode am Harz
Germany
Tel.: +49 (0) 5522 / 5007-0
Fax: +49 (0) 5522 / 5007-12
Web: www.martinchrist.de
E-mail: info@martinchrist.de

Table of contents

1	General information	9
1.1	Importance of the operating manual	9
1.2	Further applicable documents	9
1.3	Intended use	9
1.4	Warranty and liability	12
1.5	Copyright	12
1.6	Explanation of symbols	13
1.7	Standards and regulations	13
1.8	Scope of supply	13
2	Layout and mode of operation	14
2.1	Layout of the freeze-dryer	14
2.1.1	Functional and operating elements	14
2.1.2	Name plate	19
2.2	Mode of operation	20
2.2.1	General information on freeze-drying	20
2.2.2	Freeze-drying process	22
2.2.2.1	Preparation	22
2.2.2.2	Freezing	23
2.2.2.3	Main drying	23
2.2.2.4	Final drying	24
2.2.2.5	End of drying and aeration	24
2.2.2.6	Defrosting	24
3	Safety	25
3.1	Marking of the unit	25
3.2	Explanation of the symbols and notes	26
3.3	Responsibility of the operator	27
3.4	Operating personnel	28
3.5	Informal safety notes	29
3.6	Safety notes concerning the transport, set-up and connection and initial start-up of the freeze-dryer	29
3.6.1	General hazards	29
3.6.2	Hazards caused by improper transport	29
3.6.3	Hazards caused by improper set-up	30
3.6.4	Hazards caused by improper connection	30
3.6.5	Hazards during the initial start-up	30
3.7	Safety notes concerning the operation	31
3.7.1	Hazards caused by electricity	31
3.7.2	Hazards caused by the refrigeration system	31
3.7.3	Hazards caused by the hydraulic system	32
3.7.4	Hazards caused by nitrogen	33
3.7.5	Hazards caused by harmful products	34
3.7.6	Hazards caused by solvents in the products	34
3.7.7	Hazards caused by acids in the products	34

Table of contents

3.7.8	Hazards caused by azides in the products.....	35
3.7.9	Hazards caused by contaminated condensate (defrosting water)	35
3.7.10	Hazards caused by contaminated vacuum pump exhaust gases	36
3.7.11	Hazards caused by hot and contaminated vacuum pump oil	36
3.7.12	Hazards caused by the loading door.....	36
3.7.13	Hazards caused by shelves	37
3.7.14	Hazards caused by hot surfaces.....	37
3.7.15	Hazards caused by cold surfaces	37
3.7.16	Hazards caused by overpressure in the chamber	37
3.8	Safety devices	38
3.9	Procedures in the event of hazards and accidents.....	39
3.10	Maintenance and cleaning of the freeze-dryer	40
3.11	Additions or conversions of the freeze-dryer	40
3.12	Measures to be taken to ensure safe operation of the freeze-dryer.....	41
3.13	Remaining hazards.....	42
4	Storage and transport	43
4.1	Dimensions and weight.....	43
4.2	Storage conditions	43
4.3	Unpacking the freeze-dryer.....	43
4.4	Transport	44
4.4.1	Transport safety devices.....	45
5	Set-up and connection	46
5.1	Installation site	46
5.2	Supply and disposal connections.....	47
5.2.1	Power supply	47
5.2.2	Connection	47
5.2.2.1	Customer-provided fuses	47
5.2.3	Aeration.....	48
5.2.3.1	Special equipment: Precision control needle valve for air injection.....	48
5.2.4	Drain.....	49
5.2.5	Special equipment - water cooling system: cooling water inlet and outlet	49
5.2.6	Vacuum pump	51
5.2.7	Pressure control valve	52
5.2.8	Vacuum sensor.....	53
5.2.9	Drying cartridge (adsorption filter).....	54
6	Operation.....	55
6.1	Initial start-up	55
6.2	Installation of accessories	55
6.3	Preparation	55
6.4	Switching the freeze-dryer on	55
6.5	Loading door.....	56

Table of contents

6.6	Hydraulic system	57
6.6.1	Manually operated shelf movement	57
6.6.2	Special equipment: stainless steel bellow for the hydraulic cylinder	58
6.6.3	Special equipment: changing the distance between the shelves	59
6.7	LSCplus control system	61
6.7.1	User interface	61
6.7.1.1	Main window "Manual"	62
6.7.1.2	Main window "Program"	75
6.7.1.3	Main window "Options"	76
6.7.1.4	Main window "?"	90
6.7.2	Manual freeze-drying	90
6.7.2.1	Entering set values in the manual mode	91
6.7.3	Freeze-drying with the PGMplus programmer module	93
6.7.3.1	Creating a program	97
6.7.3.2	Editing a program	105
6.7.3.3	Copying a program	106
6.7.3.4	Loading a program	106
6.7.3.5	Deleting a program	107
6.8	Optional extensions and special equipment	108
6.9	Switching the freeze-dryer OFF	110
7	Malfunctions and error correction	111
7.1	General malfunctions	111
7.1.1	Power failure	112
7.1.2	Insufficient vacuum	113
7.1.2.1	Small flange connections	113
7.1.2.2	Aeration valve, media drain valve	114
7.1.2.3	Pressure control valve	114
7.1.2.4	Vacuum sensor	114
7.1.3	Insufficient ice condenser temperature	115
7.2	Process and error messages	115
7.3	Service contact	116
8	Maintenance and service	117
8.1	Maintenance	117
8.1.1	General	117
8.1.2	Ice condenser chamber	119
8.1.3	Drying chamber	119
8.1.3.1	Lamination of the loading door with a special film	119
8.1.3.2	Special equipment: Stainless steel door latch at the loading door	120
8.1.4	Aeration valve, media drain valve	121
8.1.5	Heat exchanger (only air cooled freeze-dryers)	122
8.1.6	Electrical system	122
8.1.7	Vacuum system	123
8.1.8	Refrigeration system	124
8.1.9	Heat transfer medium system	125

Table of contents

8.1.10	Hydraulic system	125
8.1.11	Vacuum sensor.....	125
8.1.12	Accessories	126
8.2	Disinfection of the drying chamber and accessories	126
8.3	Maintenance schedule	127
8.4	Service	129
8.5	Return of defective parts.....	129
9	Disposal.....	131
9.1	Disposal of the freeze-dryer	131
9.2	Disposal of the packaging.....	131
10	Technical data.....	132
10.1	Ambient conditions	134
10.2	Technical documentation	134
11	Appendix	135
11.1	Mathematical relations.....	135
11.2	EC declaration of conformity in accordance with the EC Machinery Directive	137
11.3	EC declaration of conformity in accordance with the Pressure Equipment Directive	139
11.4	Table of the sublimation pressure curve.....	141
12	Glossary	143
13	Index	145

1 General information

1.1 Importance of the operating manual

A fundamental requirement for the safe and trouble-free operation of the unit is to be familiar with the fundamental safety instructions and all possible hazards.

The operating manual includes important information concerning the safe operation of the freeze-dryer.

This operating manual, and in particular the notes on safety and hazards, must be observed by all persons operating the unit.

In addition, the local rules and regulations for the prevention of accidents must be complied with.

1.2 Further applicable documents

The following documents apply in addition to these operating instructions if the freeze-dryer is equipped with the corresponding features:

- Operating instructions of the CHRIST SCADA software LPCplus (instructions for the operation of the freeze-dryer by way of a SCADA system)

1.3 Intended use

The freeze-dryer has been exclusively designed for the freeze-drying of solid or liquid products in ampoules, vials or dishes. It is, therefore, solely intended for this application.

All of the process steps that are necessary for freeze-drying can be performed in the system:

- freezing of the products with time and temperature setpoints that can be preset as desired
- main drying of the products with time, temperature and pressure setpoints (sublimation) that can be preset as desired
- secondary drying of the products with time and temperature setpoints that can be preset as desired, and with a high final vacuum for eliminating any water that is bound by capillary or molecular effects (desorption)

The freeze-dryer is suitable for freeze-drying solid substances and aqueous solutions (e.g. bacteria and virus cultures, blood plasma, serum fractions, antibodies, sera, vaccines and pharmaceutical products such as chloramphenicol, streptomycin, vitamins, ferments and plant extracts for biochemical tests).

1 General information

Freeze-drying of solvent-containing products (non-aqueous media)

With regards of corrosion resistance, the use of some organic solvents in aqueous solutions with low concentrations is acceptable.

A freeze-dryer is designed to be chemically resistant to most compounds that are commonly used in freeze-drying processes. However, by necessity, the freeze-dryer is comprised of several different materials, some of which may be attacked and degraded by certain chemicals.

The methods of fabrication and/or conditions of exposure of an acrylic door, as well as the way the chemicals are applied, can influence the results. Some of these factors are listed below:

- Fabrication: Stress generated while sawing, sanding, machining, drilling, polishing, and/or forming.
- Exposure: Length of exposure, stresses induced during the life of the product due to various loads, changes in temperature etc.
- Application of chemicals: by contact, rubbing, wiping, spraying etc.

The following table can be used as a general guide for the expected degradation during normal freeze-drying processes of organic solvents with a total max. concentration of 10 vol-% in aqueous solutions.

Solvent	Acrylic glass	Stainless steel	Silicon rubber	EPDM
Acetic acid 20%	+	+	+	o
Formic acid	+	+	o	-
Trifluoroacetic acid (TFA)	-	+	-	+
Calcium chloride	+	o	+	+
Sodium phosphate	+	+	-	+
Acetone	-	+	+	+
Acetonitrile	-	+	+	+
Carbon tetrachloride	-	+	-	-
Cyclohexane	+	+	-	-
Dioxane	+	+	-	o
Methyl-t-butyl ether	+	+	o	-
Pyridine	+	+	-	-
Methanol	-	+	+	+
Ethanol	o	+	+	+
tert-Butanol	-	+	o	o
DMSO	-	+	+	+

Legend: + No degradation to be expected
 o Moderate degradation; limited use
 - Severe degradation; infrequent use recommended;
 immediate thorough cleaning required

The use of other solvents, e.g. ammonia, should be avoided.

The chemical attack on devices and accessory components can be significantly reduced by immediate cleaning after the end of operation. All parts of the freeze-dryer that have come in contact with the product must be checked regularly for damages and replaced if necessary.

1 General information

The following features are not permissible or must be deactivated:

- omission or removal of product temperature sensors of the PT100 or LyoRx type or of specially connected PT100 sensors (with a cable connection),
- omission or removal of WTMplus,
- omission of the LyoCoN process or removal of the LyoCoN reservoir and sealing of the access opening.



NOTE

Solvents that are not listed in the table above, or the listed solvents in a concentration higher than 10% by volume, must not be used!

Freeze-drying of acid-containing products

Freeze-drying of products containing acids is only permissible if special protective measures and equipment-related precautions are taken. Otherwise, there is a risk of damage to property and personal injury. Consultation of Martin Christ Gefriertrocknungsanlagen GmbH is absolutely mandatory in order to define the measures that need to be taken!

Freeze-drying of azide-containing products

Freeze-drying of products containing azides is only permissible following a case-by-case examination and the written approval by Martin Christ Gefriertrocknungsanlagen GmbH, since azides may form explosive dust-air-mixtures and also explosive metal azides when combined with non-ferrous metals (e.g. copper, brass, bronze)!

Decontamination with hydrogen peroxide (H₂O₂)

Decontamination of the freeze-dryer with hydrogen peroxide (H₂O₂) in combination with an H₂O₂ steam generator is only permissible if the freeze-dryer is equipped with the following:

- key switch for H₂O₂ operation,
- removable handles,
- flange connections with specially secured locks on the chamber,
- adapted control system.

The following features are not permissible or must be deactivated:

- omission of the LyoCoN process or removal of the LyoCoN reservoir and secured sealing of the access opening.

Otherwise, there is a risk of personal injury. Consultation of Martin Christ Gefriertrocknungsanlagen GmbH is absolutely mandatory in order to define the measures that need to be taken!

Any other use beyond this area of application is regarded as improper use. Martin Christ Gefriertrocknungsanlagen GmbH cannot be held liable for any damage resulting from such improper use.

1 General information

The intended use also includes:

- observation of all of the notes and instructions that are included in the operating manual;
- compliance with the inspection and maintenance instructions.

The following operations are regarded as **NOT PERMISSIBLE**:

- operation of the freeze-dryer if it is not properly installed;
- use of the freeze-dryer if it is not in a perfect technical state;
- use of the freeze-dryer within hazardous locations where there is a risk of explosions;
- use of the freeze-dryer with unauthorised additions or conversions without the written approval by Martin Christ Gefriertrocknungsanlagen GmbH;
- use of the freeze-dryer with accessories that have not been approved by Martin Christ Gefriertrocknungsanlagen GmbH, with the exception of commercially available freeze-drying vessels made of glass or plastic;
- use of the freeze-dryer with concentrated solvents;
- freeze-drying of products that may react during the freeze-drying process following the supply of high amounts of energy;
- freeze-drying of products that may damage the material of the chamber walls, shelves, pipes, or seals, or that may affect the mechanical strength.

1.4 Warranty and liability

The warranty and liability are subject to our "General Terms and Conditions" that were distributed to the operator upon the conclusion of the contract.

Warranty and liability claims are excluded if they are due to one or several of the following reasons:

- improper use
- non-compliance with the safety instructions and hazard warnings in the operating manual
- improper installation, start-up, operation, and maintenance of the freeze-dryer.

1.5 Copyright

The copyright concerning the operating manual remains with Martin Christ Gefriertrocknungsanlagen GmbH.

The operating manual is solely intended for the operator and their personnel. It includes instructions and information that may not be

- duplicated,
- distributed, or
- communicated in any other way neither in full nor in parts.

Non-compliance may be prosecuted under criminal law.

1.6 Explanation of symbols

In this operating manual, specialist terms that are explained in the glossary (see chapter 12 - "Glossary") are marked by an arrow and printed in italics (e.g. → *sublimation*).

1.7 Standards and regulations

EC declaration of conformity in accordance with the EC Machinery Directive and EC declaration in accordance with the Pressure Equipment Directive (see chapter 11.2 - "EC declaration of conformity in accordance with the EC Machinery Directive" and chapter 11.3 - "EC declaration of conformity in accordance with the Pressure Equipment Directive").

1.8 Scope of supply

The scope of supply comprises:

- 1 tube of high-vacuum grease
- 1 litre of vacuum pump oil (only if a pump is included)
- 1 set of flange components and several small parts for service and maintenance purposes
- 1 drain hose 0.5 m (silicone 8 x 12 mm)
- 1 operating manual

If the special equipment of a stainless-steel door latch at the loading door is included:

- 1 slide pad for the door latch (part no. 177270; see chapter 8.1.3.2 - "Special equipment: Stainless steel door latch at the loading door")

Accessories and commissioning

According to your order, our order confirmation, and our delivery note.

2 Layout and mode of operation

2 Layout and mode of operation

2.1 Layout of the freeze-dryer

2.1.1 Functional and operating elements

- 1 Control system
- 2 Drying chamber with loading door

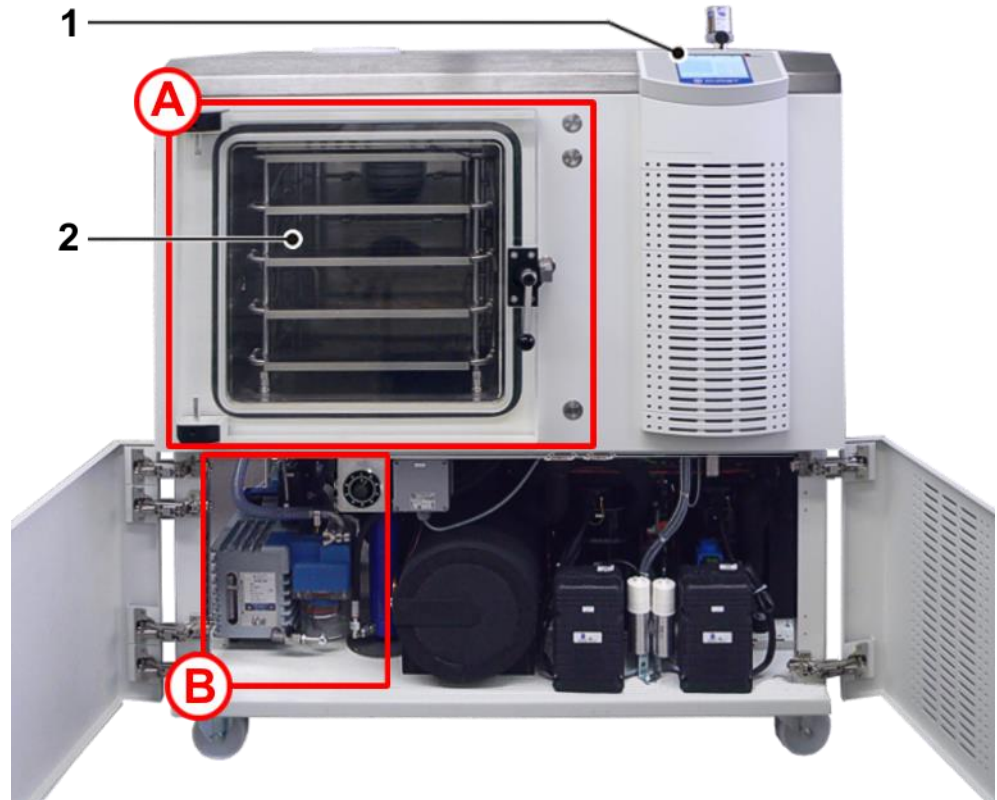

Fig. 1: Front of the freeze-dryer

- 3 Connections for the product sensors
- 4 Connection for the intermediate valve
- 5 Intermediate valve
- 6 Shelves
- 7 Hydraulic dome with bellows
- 8 Push-button "Up" (hydraulic system)
- 9 Push-button "Down" (hydraulic system)
- 10 Door latch
- 11 Push-button "Release" for two-hand control of the hydraulic system



Fig. 2: Detailed view A – drying chamber

2 Layout and mode of operation

- 12 Option: Precision control needle valve
- 13 Pressure control valve
- 14 Vacuum pump
- 15 Exhaust filter (oil mist separator)

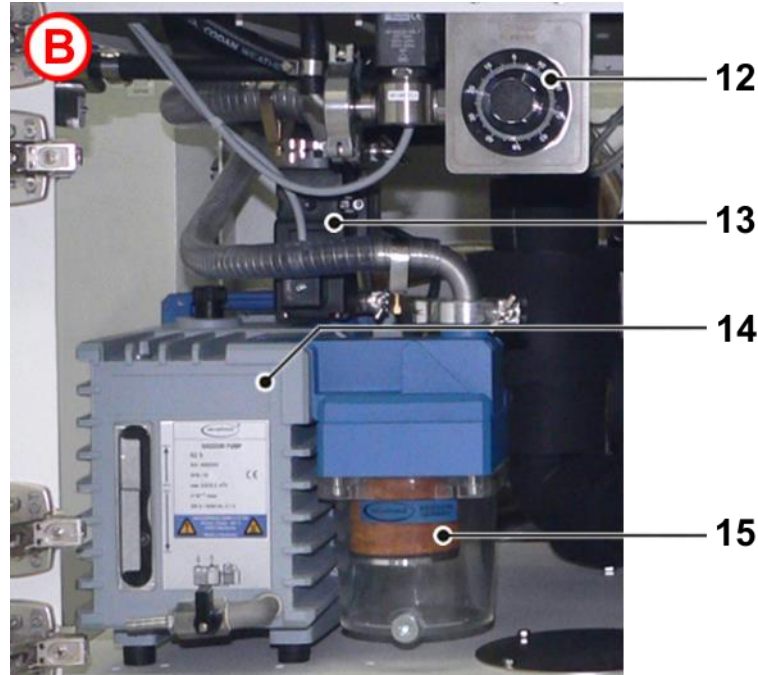

Fig. 3: Detailed view B - vacuum pump

- 16 Mains power switch
- 17 Switch cabinet (behind the side panel)
- 18 Sight glass of the heat transfer medium
- 19 Steerable castors

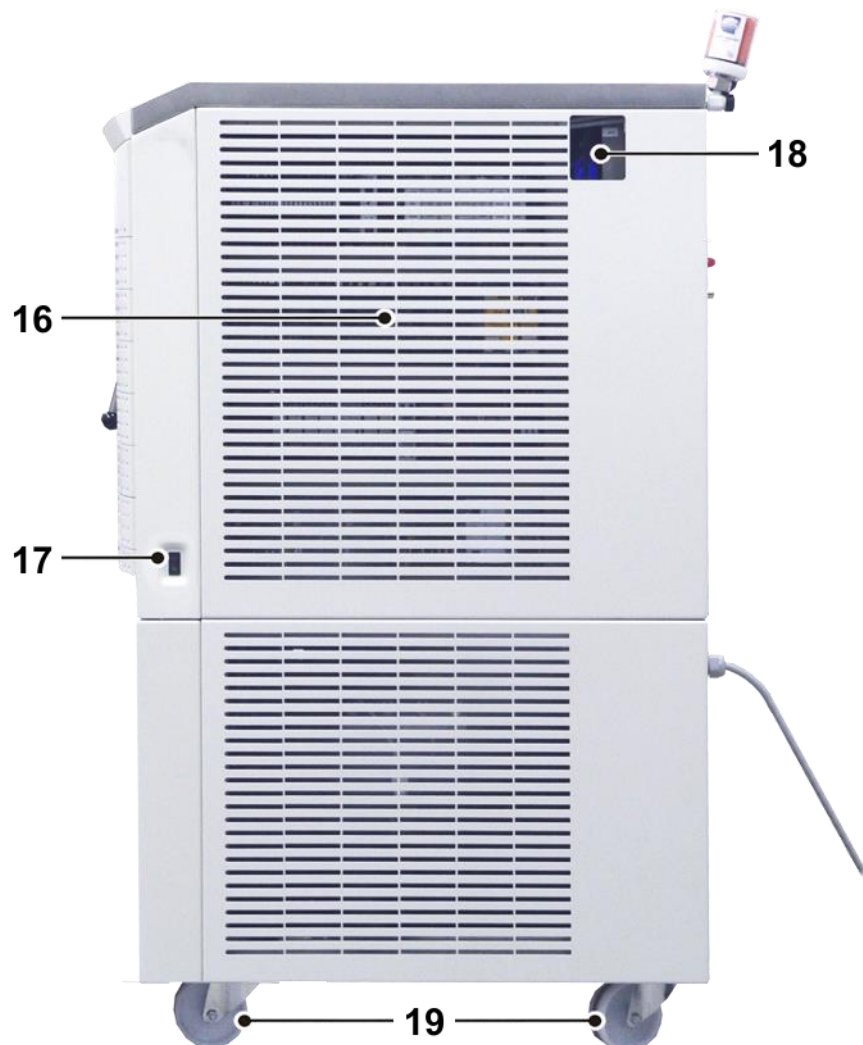

Fig. 4: Right side of the freeze-dryer

2 Layout and mode of operation

- 20 Option: capacitive vacuum sensor (behind the side panel)
- 21 Option: pressure control sensor (behind the side panel)
- 22 Vacuum sensor VCP63MV (behind the side panel)
- 23 Sight glass of the ice condenser
- 24 Aeration valve
- 25 Access flange DN40 (e.g. for weighing device, behind the side panel)
- 26 Media drain valve of the ice condenser chamber
- 27 Fixed castors

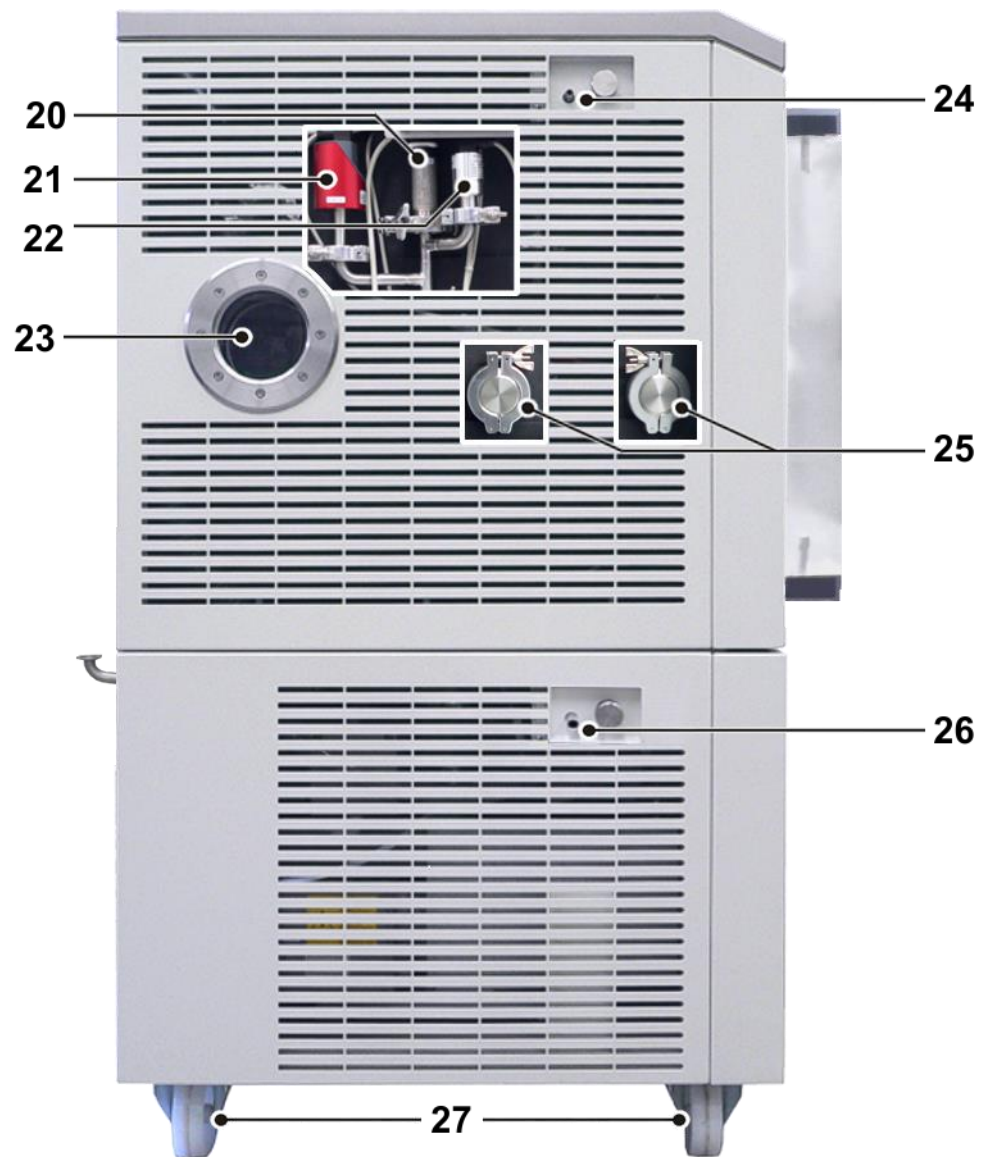

Fig. 5: Left side of the freeze-dryer

2 Layout and mode of operation

Air-cooled freeze-dryer:

- 28 Connection valve for the adsorption filter
- 29 Main switch
- 30 Ethernet interface
- 31 Option: serial interface
- 32 Heat exchanger for the heat transfer medium (behind the panel)
- 33 Mains cable
- 34 Heat exchanger of the refrigeration unit (behind the panel)
- 35 Name plate
- 36 Option: Access flange
- 37 Vacuum connection

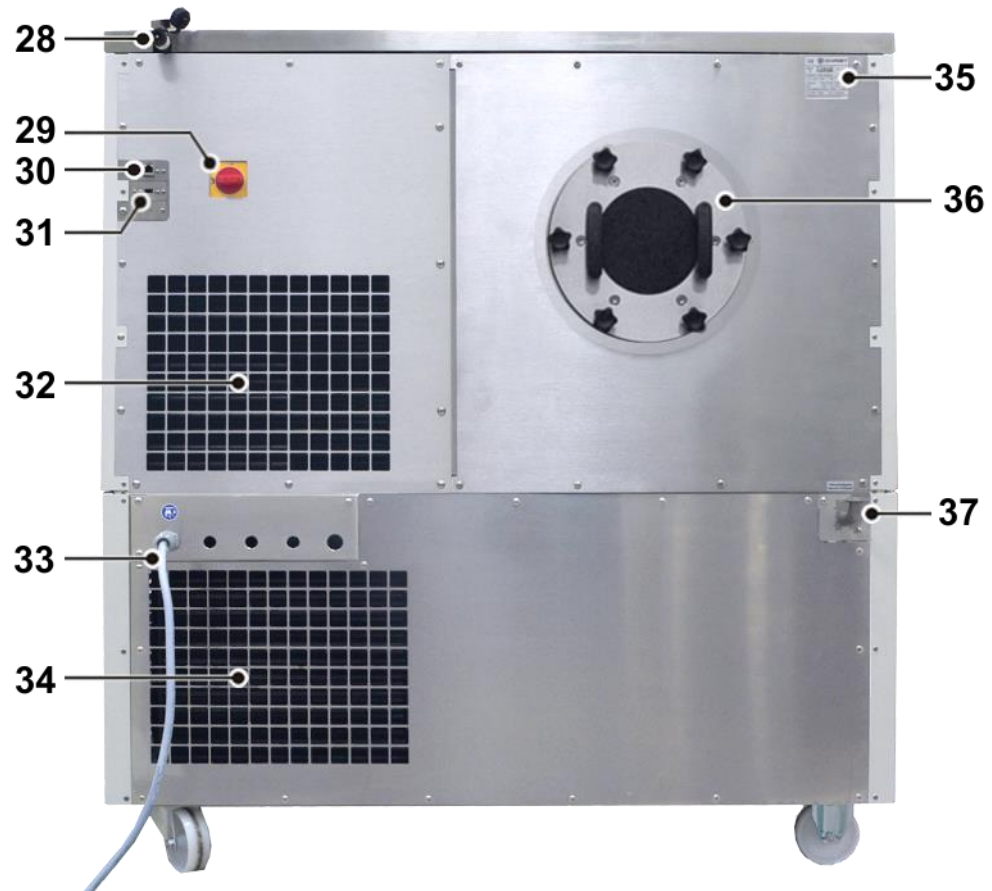

Fig. 6: Rear view of an air-cooled freeze-dryer

2 Layout and mode of operation

Water-cooled freeze-dryer:

- 38 Pressure gauge of refrigeration system 2
- 39 Media connector block
- 40 Pressure gauge of refrigeration system 1

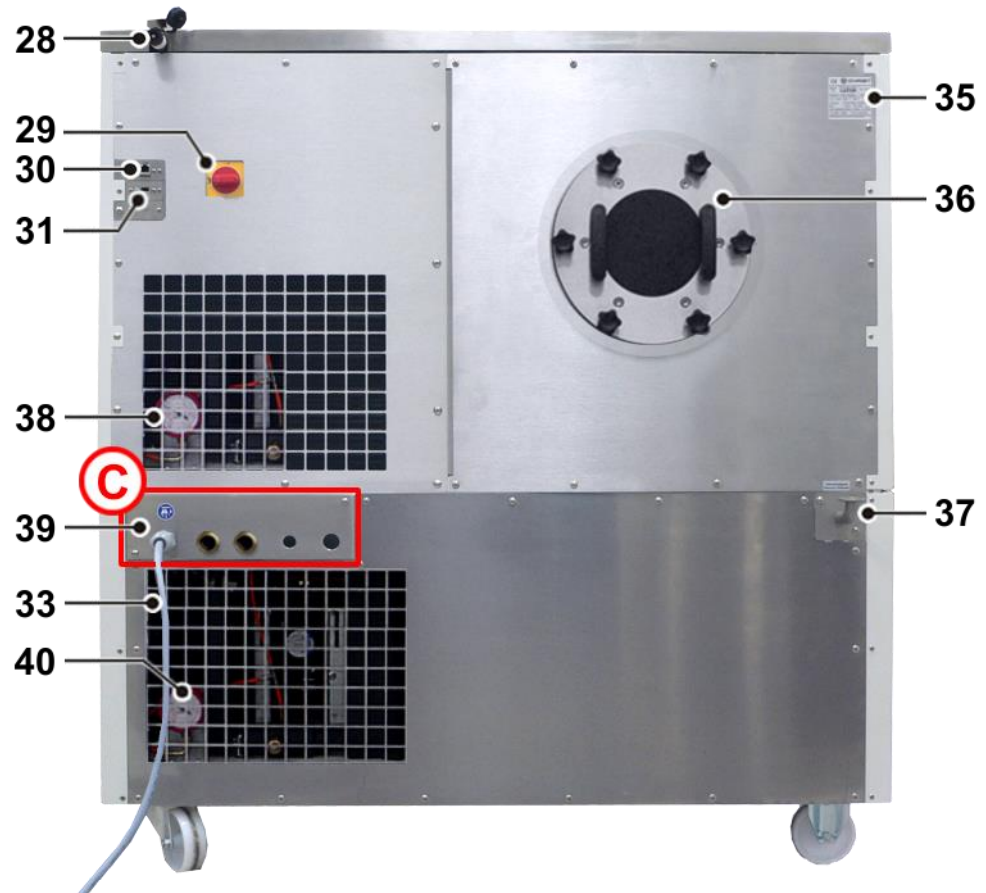

Fig. 7: Rear view of a water-cooled freeze-dryer

- 41 Connector for the cooling water inlet
- 42 Connector for the cooling water outlet
- 43 Media drain valve of the ice condenser chamber (alternatively to item 23)

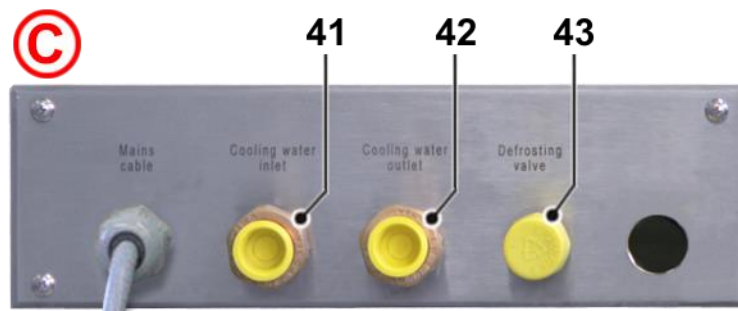
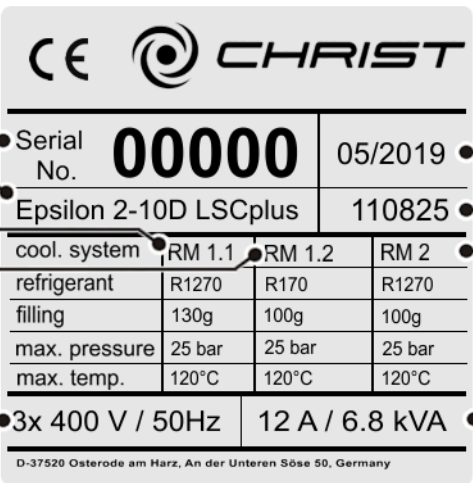

Fig. 8: Detailed view C - media connector block

2 Layout and mode of operation

2.1.2 Name plate

- 1 Serial number
- 2 Type
- 3 Refrigerant data of RM 1, 1st stage
- 4 Refrigerant data of RM 1, 2nd stage
- 5 Nominal voltage
- 6 Year of manufacture (month/year)
- 7 Part number
- 8 Refrigerant data of RM 2
- 9 Rated current / apparent power



cool. system		RM 1.1	RM 1.2	RM 2
refrigerant	R1270	R170	R1270	
filling	130g	100g	100g	
max. pressure	25 bar	25 bar	25 bar	
max. temp.	120°C	120°C	120°C	

Serial No. **00000** 05/2019

Epsilon 2-10D LSCplus 110825

3x 400 V / 50Hz 12 A / 6.8 kVA

D-37520 Osterode am Harz, An der Unteren Söse 50, Germany

Fig. 9: Example of a name plate (enlarged photo)

2 Layout and mode of operation

2.2 Mode of operation

2.2.1 General information on freeze-drying

What is freeze-drying?

Freeze-drying or lyophilisation is a procedure for the gentle drying of high-quality products. The product is dried by → *sublimation* without passing through the liquid phase.

What are typical applications for freeze-drying?

An important area of application is the drying of biotechnological and pharmaceutical products, e.g. tissues and tissue extracts, bacteria, vaccines, and sera. Products that would not keep well when they are dissolved in water can be preserved by freeze-drying. During this process, the biological properties of these sensitive substances are preserved. The compounds remain unchanged from a qualitative and quantitative point of view. After the addition of water, the products will have the same characteristics as the original products.

How does freeze-drying work?

Freeze-drying is a very gentle procedure for the extraction of water from a product in the frozen state. The drying process takes place through → *sublimation*, i.e. the direct transition of a product from the solid phase to the gas phase. This happens under vacuum.

The following section describes the process of sublimation based on the example of water, since most products that are processed by freeze-drying are aqueous solutions. Their behaviour is based on identical fundamental principles.

The vapour pressure curve for ice and water (sublimation pressure curve) describes the phase transition as a function of the pressure and temperature. The higher the temperature is, the higher the vapour pressure.

- If the vapour pressure is higher than 6.11 mbar (A), water passes through all three phases: solid, liquid, and gas (see the illustration).
- At 6.11 mbar and 0.0098°C, the melting pressure curve, vapor pressure curve, and sublimation pressure curve meet in one point, the so-called triple point. In this point, all three phases coexist (simultaneously).
- If the vapour pressure is below 6.11 mbar (B) and energy is added, the ice will be directly converted into water vapour once the sublimation curve is reached. This transition is called “sublimation”. If thermal energy is added to pure ice with a temperature of less than –30°C at a pressure of 0.37 mbar, it will be converted into water vapour once it reaches –30°C (see figure).

The vacuum prevents the melting of ice when energy is added. If thermal energy is added to a frozen product under vacuum, thawing of the product will be prevented and the water that is contained within the product will be released in the form of water vapour.

2 Layout and mode of operation

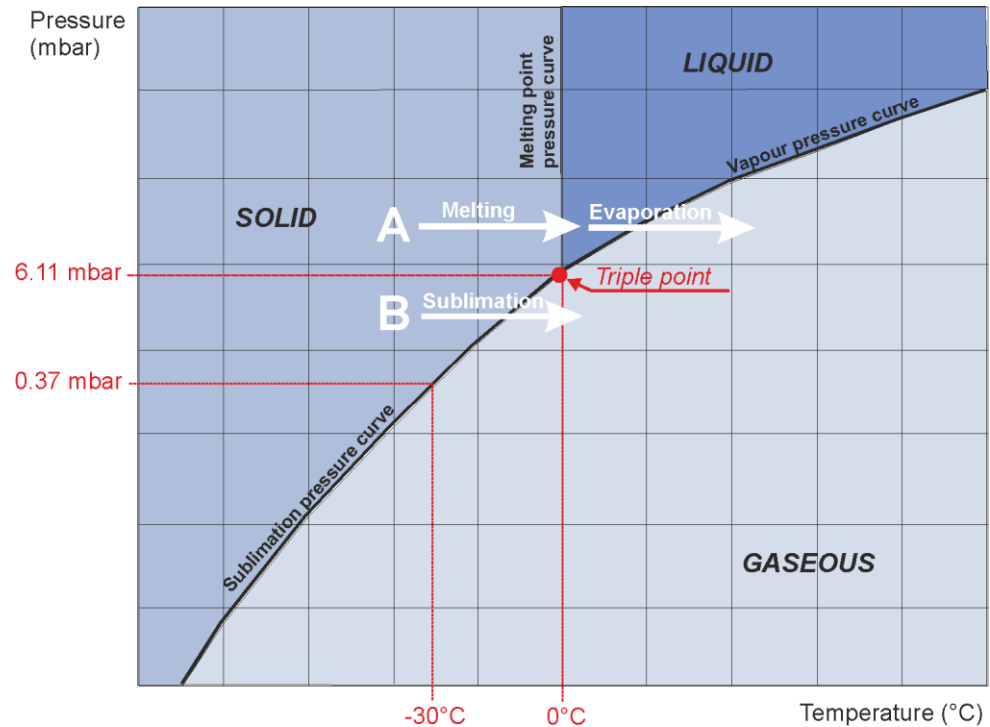

Fig. 10: Vapour pressure curve for ice and water

From a physical point of view, the freeze-drying process covers three phases (see figure below):

(1) Freezing: The product to be dried is frozen under atmospheric pressure. This can be done either directly in the freeze-dryer or in a separate deep-freeze. The freezing temperature should be approximately 10°C below the solidification point of the product.

(2) Evacuation: When the product is sufficiently frozen, the vacuum pump is activated. The pressure inside the drying chamber will be lowered to the value that corresponds to the freezing temperature in accordance with the vapour pressure curve for ice and water.

(3) Sublimation: Thermal energy is added to the product, thus starting the sublimation process. Due to the added energy, the water in the product is converted into water vapour. Since the ice condenser is much colder than the product that is to be dried, the vapour pressure in the ice condenser is considerably lower than above the product. As a result, the water vapour that is released by the product streams to the ice condenser, where it condenses on the condenser coils.

Once the free water has been extracted from the product during the main drying phase, the last traces of bound water will also be removed at a final pressure that is as low as possible and at higher temperatures. This takes place by way of → *desorption*. This drying phase is also called final drying.

2 Layout and mode of operation

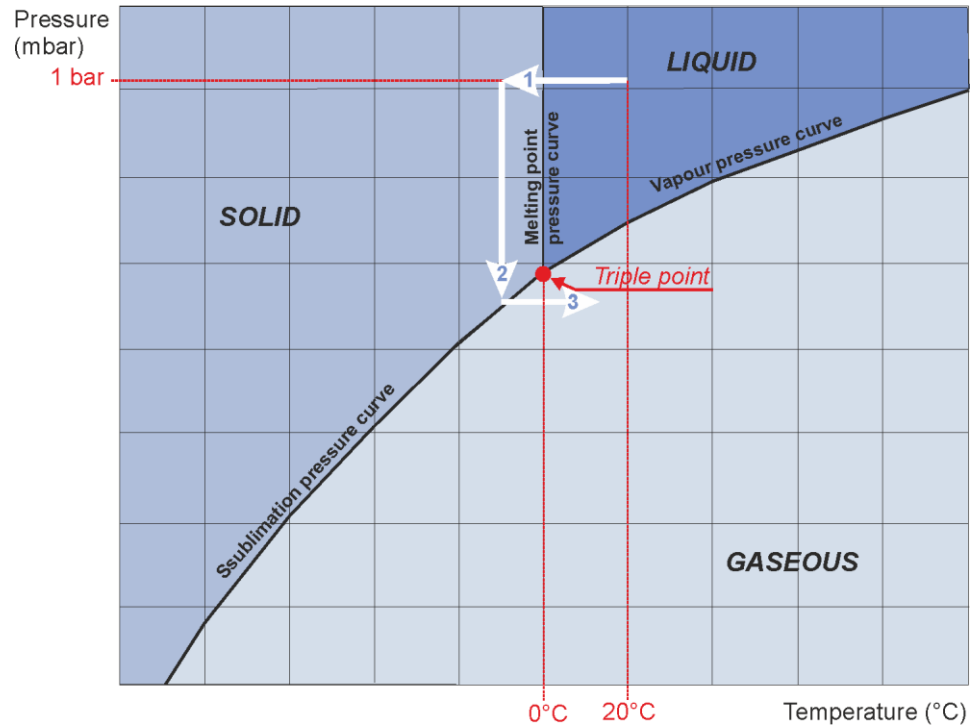

Fig. 11: Freeze-drying phases



Please find further information about basic principles, optimum procedures and applications in the brochure "Smart freeze-drying", which can be downloaded at www.martinchrist.de → [Applications] → [Lyophilisation].

2.2.2 Freeze-drying process

The main components of a freeze-dryer are:

- vacuum drying chamber or drying manifold,
- vacuum pump for generating a vacuum inside the drying chamber,
- ice condenser for binding the water vapour that is released by the product.

2.2.2.1 Preparation

The ice condenser chamber must be clean and dry. Any water residues from a preceding drying run must be removed.

The media drain valve and the aeration valve must be closed.

In the case of units that are equipped with a pressure control valve (standard on LSCplus and LSCbasic units), the vacuum pump should be warmed up ("warm-up") for at least 15 minutes prior to the start of the main drying phase. Do not subject the vacuum pump to condensable gases until the operating temperature is reached. In this way, the service life of the vacuum pump can be extended.

At the same time, the ice condenser is pre-cooled ("cool-down"). The ice condenser temperature does not have any influence on the product temperature. The sole purpose of the ice condenser is to bind the released water vapour.

2 Layout and mode of operation

2.2.2.2 Freezing

First, the product that is to be dried is frozen. This can be carried out either directly in the freeze-dryer or in a separate deep-freeze. Especially in the case of small filling quantities, we recommend pre-cooling the shelves as well in order to prevent the product from thawing during the evacuation.

Two very different structures of the frozen material can be distinguished:

- crystalline structures with clearly distinguishable crystals
- amorphous structures with no crystal junctions at all (e.g. glass)

The majority of the freeze-drying products have a crystalline form.

When freezing these kinds of products, one must take into consideration that too deep and too quick freezing leads to smaller ice crystals, which has a negative effect on the duration of the drying process.

For every product to be dried, the solidification point must be determined as a first step. This is the point at which the water that is contained in the product has completely crystallised. In order to ensure an optimum freeze-drying process, the product temperature should be approximately 10°C below the solidification point.

2.2.2.3 Main drying

When the product is frozen, the main drying phase commences. The vacuum pump is switched on. The pressure inside the drying chamber will be lowered to the value that corresponds to the freezing temperature in accordance with the vapour pressure curve for ice and water (sublimation pressure curve). At the same time, thermal energy will be added to the product. In the case of products in round-bottom flasks, wide-neck bottles, etc., this is realised through the environment that is considerably warmer (direct contact heat), in the case of unheated shelves by way of thermal radiation from the environment, and in the case of temperature-controlled shelves directly via the shelves. As a result, the sublimation process starts.

At the beginning of the drying process, the maximum drying rate will be reached. The more the sublimation area recedes into the product, the further the produced water vapour must pass through the layers that have already been dried.

Under certain conditions, it is possible that the vacuum inside the ice condenser chamber increases during the main drying phase (e.g. from 0.63 mbar to 0.47 mbar) although the valve towards the vacuum pump is closed. From a physical point of view, this is due to the pumping effect of the ice condenser ("cryo-pumping effect").

The required drying time depends strongly on the drying vacuum. At 1.0 mbar, one gram of ice takes up a volume of 1 m³ of vapour, at 0.1 mbar a volume of 10 m³ of vapour, and at 0.001 mbar a volume of 100 m³. The closer the vacuum is to the solidification point, the smaller is the resulting vapour volume. The drying rate increases and the drying time decreases.

2 Layout and mode of operation

2.2.2.4 Final drying

Final drying is an option whenever one requires a product with minimal residual moisture. In the physical sense, this process is a desorption process, i.e. the removal of adsorptively bound water. Final drying is performed under the lowest possible final pressure that depends on the ice condenser temperature in accordance with the vapour pressure curve for ice and water as well as on the final vacuum of the vacuum pump that is used. The process is supported by a higher shelf temperature.

2.2.2.5 End of drying and aeration

The end of the drying process is reached when both the product and shelf temperature are clearly in the positive range (+15 to +20°C) and if their difference is not greater than 5 K.

Another indication of the end of the drying process is the behaviour of the vacuum and of the ice condenser temperature. The ice condenser is no longer subject to load and reaches the final temperature of approximately -55°C or -85°C. The pressure in the drying chamber decreases in accordance with the ice condenser temperature.

The vacuum pump will be switched off and the drying chamber will be aerated via a rubber valve or via the aeration valve. The aeration valve can also be used to flood the unit with nitrogen or another inert gas instead of ambient air.

Then, the product can be removed from the unit.

2.2.2.6 Defrosting

Defrosting with hot gas













As standard, the freeze-dryer is equipped with a hot-gas defrosting system. In order to defrost the ice condenser, heated refrigerant is fed through the heating coil. In addition, the bottom of the ice condenser chamber is heated by way of a heating collar.

In order to avoid damage, the condensate must be drained off through the media drain valve directly after the completion of the defrosting process. Then, any residual water must be removed from the ice condenser chamber by way of a cloth.

3 Safety

3.1 Marking of the unit

The following symbols are used for Christ freeze-dryers:

	Dangerous voltage		On (Power)
	Hot surface		Off (Power)
	Caution! Risk of bruising		Name plate (see chapter 0 - "Name plate")
	Attention, consult the operating manual		Filled with natural inflammable refrigerants
	Protective earth (ground)		CE mark in compliance with the directive 2006/42/EC
	Earth (ground)		China RoHS 2 mark (only for China)
	Unplug the mains plug		

i
NOTE

Safety indications on the freeze-dryer must be kept readable at all times. If necessary, they must be replaced.

i
NOTE

Not all of the symbols/labels are used for this type of freeze-dryer.

3 Safety

3.2 Explanation of the symbols and notes

This operating manual uses the following names and symbols to indicate hazards:



This symbol stands for a **direct** hazard to the life and health of persons.

Non-observance of these symbols **causes** serious health problems up to life-endangering injuries.



This symbol stands for a **direct** hazard to the life and health of persons due to electrical voltage.

Non-observance of these symbols **causes** serious health problems up to life-endangering injuries.



This symbol stands for a **potential** hazard to the life and health of persons.

Non-observance of these symbols **can** cause serious health problems up to life-endangering injuries.



This symbol indicates a potentially hazardous situation

Non-observance of these notes can cause minor injuries or damage to property.



This symbol indicates important information.

3.3 Responsibility of the operator

Operating personnel

The operator is obliged to ensure that the persons working on/with the freeze-dryer

- are 18 years old or older,
- have been specifically ordered to do so by the operator/owner and that they have been duly informed about the specific hazards associated with the system, supply media and starting/final products as well as about the correct conduct and necessary measures to take in the event of accidents or malfunctions,
- are familiar with the fundamental health, safety and accident prevention regulations,
- have been trained in terms of the operation of this system,
- have read and understood this operating manual (in particular the safety sections and warning notes) and confirmed this with their signature.

The areas of responsibility of the personnel concerning the operation, maintenance and care of the unit must be clearly defined.

The safety-conscious work of the personnel in compliance with the operating manual and the relevant EC health and safety directives and the national laws concerning health and safety and the prevention of accidents must be checked at regular intervals (e.g. every month).

Special equipment – H₂O₂ decontamination system: additional points concerning decontamination with hydrogen peroxide (H₂O₂)

The operator is committed to having the decontamination of the freeze-dryer performed solely by personnel

- who have been specifically ordered to do so by the operator and who have been duly informed about the specific hazards associated with hydrogen peroxide and about its safe handling based on the special operating instructions/SOPs,
- who have been instructed by specialised personnel concerning the operation of the hydrogen peroxide steam generator and freeze-dryer and, in particular, concerning the "H₂O₂ decontamination" mode.

Working area

The operator is responsible for

- performing a risk assessment concerning potential accidents in connection with the freeze-dryer and take design-related countermeasures, if necessary.
- performing a compatibility test of all the substances that are used in the freeze-dryer (products to be dried as well as cleaning agents, etc.) and that come into contact with the chamber walls, shelves, pipes/hoses and seals. Substances that damage the material or weaken the mechanical strength must not be used.
- having maintained the system at regular intervals (see chapter 8 - "Maintenance and service").
- having the safety devices checked regularly in terms of their correct operation (see chapter 3.8 - "Safety devices")

3 Safety

Any parts or components that are not in perfect working order must be replaced without delay.

Special equipment for freeze-drying applications involving solvents:
Additional points concerning the freeze-drying of solvent-containing
products

With regards of corrosion resistance, the use of some organic solvents in aqueous solutions with low concentrations is acceptable.

Under certain circumstances, the freeze-drying of products containing solvents may lead to the formation of explosive mixtures. This is why the operator must draw up special operating instructions/SOPs including precise instructions

- concerning the deactivation of specific components, such as WTMplus, LyoCoN, PT100 (see chapter 1.3 - "Intended use", section "Freeze-drying of solvent-containing products"),
- concerning the chamber pressure and shelf temperature for every product that is to be processed in the freeze-dryer (see the table in chapter 1.3 - "Intended use"),
- concerning the inspection of the freeze-dryer in view of damage caused by the solvent that is used (see chapter 1.3 - "Intended use", section "Freeze-drying of solvent-containing products").

Special equipment – H₂O₂ decontamination system: additional points
concerning decontamination with hydrogen peroxide (H₂O₂)

The operator must ensure that detectors for hydrogen peroxide vapour are installed in the room in which the freeze-dryer is used and that these detectors are checked at regular intervals.

The operator must draw up special operating instructions/SOPs including precise instructions

- concerning the decontamination of the freeze-dryer with hydrogen peroxide,
- concerning the deactivation of specific components, such as WTMplus, LyoCoN, PT100 (siehe chapter 1.3 - "Intended use", section "Decontamination with hydrogen peroxide (H₂O₂)").

3.4 Operating personnel

It must be ensured that persons operating the unit

- are 18 years old or older,
- have been specifically ordered to operate the unit and made aware of dangers originating from the freeze-dryer, supply media, starting and end products by the operator,
- be familiar with the fundamental regulations concerning workplace safety and accident prevention
- have been trained in terms of the operation of this unit, and
- have read and understood this operating manual (and in particular the safety sections and warning notes) and confirmed this with their signature.

3.5 Informal safety notes

This operating manual is part of the product.

- This operating manual must be kept at the location of use of the freeze-dryer. Ensure that it is accessible at all times.
- The operating manual must be handed over to every subsequent owner or user of the freeze-dryer.
- Any changes, additions or updates received must be added to the operating manual.
- In addition to the operating manual, the general and operational rules and regulations for the prevention of accidents and the protection of the environment must be provided.
- All of the safety and hazards notes on the freeze-dryer must be kept readable at all times. If necessary, they must be replaced.

3.6 Safety notes concerning the transport, set-up and connection and initial start-up of the freeze-dryer

The following notes and instructions must be observed in order to protect all persons and property.

3.6.1 General hazards



WARNING

General risk of injury

Among the general hazards during the transport, set-up and connection and start-up of the freeze-dryer are impact hazards, crushing hazards, grazing hazards, cutting hazards, etc.

This may lead to severe injuries.

- Comply with the fundamental health and safety rules and regulations as well as with the rules and regulations for the prevention of accidents!
- Wear personal protective equipment (safety shoes, work gloves, and hardhat)!

3.6.2 Hazards caused by improper transport



DANGER

Risk of injury caused by the uncontrolled movement of loads

Units or components that are not properly fastened or secured may shift, or fall over.

This may lead to severe damage to health or even life-threatening injuries.

- Take the centre of gravity of the load in consideration (off-centre)!
- Prior to transporting or setting-up the freeze-dryer, read the chapter 4 - "Storage and transport" thoroughly!

3 Safety

3.6.3 Hazards caused by improper set-up



WARNING

Risk of injury caused by poor accessibility of the freeze-dryer

In cramped spaces or locations with poor accessibility, sharp edges and corners may protrude into the work area.

This may lead to injuries caused by impact hazards or grazing hazards.

- Ensure that the freeze-dryer is set up freely accessible!
- Comply with the fundamental health and safety rules and regulations as well as with the rules and regulations for the prevention of accidents!

3.6.4 Hazards caused by improper connection



WARNING

Risk of injury caused by escaping media or other consequences of improper connections

Improper connections may lead to problems, e.g. a hazardous electrical incident or the escape of media (depending on the configuration of the freeze-dryer e.g. hot water, nitrogen, hydrogen peroxide), at a later time during the operation of the freeze-dryer.

This may lead to severe damage to health or even life-threatening injuries.

- Ensure that the supply and disposal connections are established by competent and specialised persons under consideration of the corresponding connection specifications (see chapter 5.2 - "Supply and disposal connections" and chapter 10 - "Technical data")!
- The connections to the on-site pipes must be force-free and torque-free!

3.6.5 Hazards during the initial start-up



WARNING

Risk of injury caused by consequences of transport damage, or improper connections (e.g. escaping media).

Leaks after the transport, set-up, and connection of the freeze-dryer may lead to problems, e.g. the escape of media (depending on the configuration of the freeze-dryer, e.g. refrigerant, heat transfer medium, hydraulic oil, nitrogen, hydrogen peroxide, etc.), at a later time during the initial start-up of the freeze-dryer.

This may lead to severe damage to health or even life-threatening injuries.

- Prior to the initial start-up of the freeze-dryer, all of the supply and disposal connections must be checked for leaks by specialised persons.

3.7 Safety notes concerning the operation

The following notes and instructions concerning the operation of the freeze-dryer must be observed in order to protect all persons and property.

3.7.1 Hazards caused by electricity



DANGER

Danger of life caused by electric shock

There is a risk of electric shock when touching current-carrying components.

This may lead to ventricular fibrillation, cardiac arrest, or respiratory paralysis.

- Only qualified electricians are authorised to perform work on the electrical system of the freeze-dryer!
- The electrical equipment of the freeze-dryer must be checked at regular intervals by a qualified electrician!
- Defects such as loose connections or burnt cables must be eliminated immediately.

3.7.2 Hazards caused by the refrigeration system



DANGER

Risk of suffocation caused by the refrigerant

When work is performed on the refrigeration system of the freeze-dryer, refrigerant may escape in the liquid or gas state and under high pressure. Gaseous refrigerant is heavier than air and high concentration levels of it may collect on the floor or in pits.

There is a risk of suffocation in the case of high concentration levels.

Possible symptoms are paralysis and unconsciousness. Affected persons do not notice the fact that they suffocate.

- Only qualified persons are authorised to perform work on the refrigeration system of the freeze-dryer!
- Ensure good aeration/extraction when working on the refrigeration system!



WARNING

Risk of cold burns or frostbite caused by the refrigerant

When work is performed on the refrigeration system of the freeze-dryer, refrigerant may escape in the liquid or gas state and under high pressure.

In the case of skin contact with liquid refrigerant, cold burns or frostbite may result.

- Only qualified persons are authorised to perform work on the refrigeration system of the freeze-dryer!

3 Safety



DANGER

Risk of explosion due to refrigerants (natural, flammable refrigerants)

The natural refrigerants used are highly flammable and can form an explosive mixture if their concentration in the ambient air is sufficiently high.

There is an explosion hazard.

- Work on the refrigeration system of the freeze-dryer must only be carried out by qualified specialist personnel who have been trained to handle flammable refrigerants!
- Ensure good ventilation and make sure that no ignition sources (e.g. soldering iron, welding equipment) are present!



WARNING

Risk of poisoning caused by the refrigerant (non-flammable refrigerants)

During its decomposition (e.g. due to naked flames or hot surfaces), hazardous/toxic gases are released.

Contact with the decomposition products may cause severe damage to health.

- Only qualified persons are authorised to perform work on the refrigeration system of the freeze-dryer!
- Do not eat, drink, or smoke when working on the refrigeration system!

3.7.3 Hazards caused by the hydraulic system



DANGER

Risk of a high pressure injection with hydraulic oil

When working on the hydraulic system of the freeze-dryer, or due to the ageing of the hose lines, hydraulic oil may escape.

Due to the high pressure, the oil may penetrate the skin. This may lead to severe injuries with the risk of embolism.

- Only qualified persons are authorised to perform work on the hydraulic system of the freeze-dryer.
- Have the hydraulic hose lines replaced at appropriate intervals (depending on the operating conditions and under consideration of the specifications and recommendations of the manufacturer) even if no safety-relevant defects can be noticed!

3.7.4 Hazards caused by nitrogen



DANGER

Risk of suffocation caused by nitrogen

If the chamber is aerated with nitrogen, the gas may escape through openings in the system (e.g. supply lines that are not properly connected or a loading door that is not closed correctly). If the freeze-dryer is equipped with an automatic, door-controlled inertisation sequence, the chamber will be flushed with nitrogen for a preset time when the loading door is closed. If the door is opened during this process, a running inertisation sequence will be interrupted. The user is then exposed to a nitrogen quantity that corresponds to the chamber volume. Frequent opening and closing of the loading door increases the nitrogen exposure accordingly.

There is a risk of suffocation in the case of high concentration levels. Possible symptoms are paralysis and unconsciousness. Affected persons do not notice the fact that they suffocate.

- Use the freeze-dryer only if it is equipped with pipes that are properly connected!
- Only qualified persons are authorised to perform work on the nitrogen lines of the freeze-dryer!

3 Safety

3.7.5 Hazards caused by harmful products



DANGER

Risk of poisoning/infection caused by the products

When loading and unloading the shelves, the personnel are exposed to the product.

Skin contact or the inhalation of particles may cause severe damage to health depending on the product in question.

- Wear suitable protective clothes, gloves, and respiratory protection or
- use an isolater sytem on the freeze-dryer!



DANGER

Risk of poisoning/infection caused by the products

When performing maintenance work on parts coming into contact with the product (e.g. all parts inside the chamber, vacuum pump), the personnel may be exposed to product residues.

Skin contact or the inhalation of particles may cause severe damage to health depending on the product in question.

- Take suitable decontamination measures prior to commencing the maintenance!
- Wear suitable protective clothes, gloves, and respiratory protection!

3.7.6 Hazards caused by solvents in the products



DANGER

Explosion hazard caused by solvents in the products

When freeze-drying products containing solvents, gas mixtures may form. These gas mixtures may be ignited on certain components of the freeze-dryer.

There is an explosion hazard.

- Solvents that are not included in the table in chapter 1.3 - "Intended use", or the listed solvents in a concentration higher than 10% by volume, must not be used!
- Refer to the safety data sheets of the products that are used!

3.7.7 Hazards caused by acids in the products



DANGER

Risk of injury caused by acids in the products

Products containing acids may damage the material of the components of the freeze-dryer and affect the mechanical strength.

This may lead to severe injuries.

Freeze-drying of products containing acids is only permissible if special protective measures and equipment-related precautions are taken!

Consultation of Martin Christ Gefriertrocknungsanlagen GmbH is absolutely mandatory in order to define the measures that need to be taken!

- Refer to the safety data sheets of the products that are used!

3.7.8 Hazards caused by azides in the products



DANGER

Explosion hazard caused by azides in the products

Azides form explosive metal azides when they come into contact with non-ferrous metals (e.g. copper, brass, bronze) that may be present in the pipe system or vacuum pump, for example. In addition, explosive dust-air-mixtures may form during the aeration process after the end of the drying phase.

There is an explosion hazard.

- Freeze-drying products containing azides is only permissible with special protective measure and equipment-related precautions (e.g. a special vacuum pump) and following a case-by-case examination and the written approval by Martin Christ Gefriertrocknungsanlagen GmbH!



DANGER

Risk of poisoning caused by azides in the products

When loading and unloading the shelves, the personnel are exposed to the product.

Skin contact or the inhalation of particles may cause severe damage to health. There is a risk of pulmonary oedemas in the case of inhalation.

- Wear suitable protective clothes, gloves, and respiratory protection or
- use an isolater sytem on the freeze-dryer!



DANGER

Risk of poisoning caused by azides in the products

When performing maintenance work on parts coming into contact with the product (e.g. all parts inside the chamber, vacuum pump), the personnel may be exposed to product residues.

Skin contact or the inhalation of particles may cause severe damage to health. There is a risk of pulmonary oedemas in the case of inhalation.

- Take suitable decontamination measures prior to commencing the maintenance!
- Wear suitable protective clothes, gloves, and respiratory protection!

3.7.9 Hazards caused by contaminated condensate (defrosting water)



WARNING

Risk of poisoning/infection caused by contaminated condensate (defrosting water)

The condensate may contain harmful substances originating from the product.

Contact with the condensate may cause severe damage to health.

- Ensure the environmentally sound disposal of the condensate in compliance with the local rules and regulations!
- Wear suitable protective clothes, gloves, and respiratory protection when performing any work on the drain system (especially when cleaning the valves and replacing the seals)!

3 Safety

3.7.10 Hazards caused by contaminated vacuum pump exhaust gases



WARNING

Risk of poisoning/infection caused by vacuum pump exhaust gases

The exhaust gases of the vacuum pump may contain harmful substances originating from the product.

Inhalation may cause severe damage to health.

- Use the freeze-dryer only if it is equipped with a pipe that is properly connected to the outlet of the vacuum pump/exhaust filter (oil mist separator) and led to the outside via the roof!
- Depending on the product that is dried in the freeze-dryer, it may be necessary to install a suitable filter system in the exhaust gas pipe!
- Compliance with the local rules and regulations concerning the protection of the environment must be ensured!

3.7.11 Hazards caused by hot and contaminated vacuum pump oil



WARNING

Risk of scalding caused by the vacuum pump oil

When working on the vacuum pump and exhaust gas filter (especially when changing the oil or filter), the maintenance personnel are exposed to the hot vacuum pump oil.

There is a risk of scalding in the event of skin contact.

- Wear suitable protective clothes and gloves!
- Use a suitable collecting vessel!



WARNING

Risk of poisoning/infection caused by the vacuum pump oil

When working on the vacuum pump and exhaust gas filter (especially when changing the oil or filter), the maintenance personnel are exposed to the vacuum pump oil, which may contain harmful substances originating from the product. In addition, synthetic oils can release toxic fumes when they are ignited or heated above 300°C.

The inhalation of the fumes that are released by the oil, or contact with the skin, can cause severe damage to health.

- Wear suitable protective clothes, gloves, and respiratory protection!
- Ensure the environmentally sound disposal of the oil in compliance with the local rules and regulations!
- Do not let the oil come into contact with tobacco products!

3.7.12 Hazards caused by the loading door



WARNING

Risk of crushing caused by the movement of the loading door

Due to its relative high mass, the movement of the loading door can hardly be slowed down or stopped.

There is a risk of crushing of body parts between the door and the front of the chamber.

- Move the loading door slowly holding the door handle when opening or closing it. Do not hold the door leaf by its edge!
- Lock the door by turning the door handle!

3.7.13 Hazards caused by shelves



DANGER

Risk of crushing caused by the movement of the shelves

The shelves can be moved upwards/downwards by hydraulic force. In addition, the shelves may sag down in an uncontrolled manner in the event of a malfunction of the hydraulic system.

There is a risk of crushing of body parts under and between the shelves.

- Do not reach into the chamber while the shelves are in movement!
- Do not manipulate, remove, or disable the two-hand-control of the shelf movement system or the door contact switch (if available) in any way!

3.7.14 Hazards caused by hot surfaces



WARNING

Risk of burns on hot surfaces

During the operation of the freeze-dryer and half an hour afterwards, the outer surface of the freeze-dryer (especially the pipes and units) may be hot.

There is a risk of burns when touching the surfaces.

- Wear suitable protective clothes and gloves!
- Do not touch the surfaces on purpose!
- Prior to performing any maintenance work on the vacuum pump or the oil mist separator, let the components cool!



WARNING

Risk of burns on hot surfaces

After a drying process, some or all of the surfaces inside the chamber (chamber walls, shelves, intermediate valve, etc.) may still be hot.

There is a risk of burns when touching the surfaces.

- Wear suitable protective clothes and gloves!
- Do not touch the surfaces on purpose!
- Prior to performing any work on the freeze-dryer, let the components cool!

3.7.15 Hazards caused by cold surfaces



WARNING

Risk of freezing to cold surfaces

The shelves and ice condenser coils can already be cold during the loading phase.

There is a risk of freezing to the shelves or ice condenser coils when touching the surfaces.

- Wear suitable protective clothes and gloves!
- Do not touch the surfaces on purpose!

3.7.16 Hazards caused by overpressure in the chamber



DANGER

Risk of injury caused by bursting of the chamber

The double chamber is designed for vacuum. It is not a pressure vessel! In the event of a malfunction, an impermissible excess pressure may build up in the chamber, which may cause the chamber to burst.

This may lead to life-threatening injuries.

- Do not use the freeze-dryer when it is pressurised (excess pressure)!
- We strongly recommend installing a pressure relief device (e.g. a safety valve or rupture disc) with a sufficient rating.

3 Safety

3.8 Safety devices



WARNING

The safety devices are aimed at protecting the operating personnel. In case of safety devices that are not operating correctly or of safety-relevant operating elements that are not freely accessible, there is a risk of severe damage to health.

- Keep the safety-relevant operating elements freely accessible at all times!
- Do not manipulate, remove, or disable the safety devices in any way!
- Check the correct operation of the safety devices at regular intervals in accordance with the applicable national and international laws, rules, and regulations concerning health and safety and the prevention of accidents!

Main switch (line disconnecter) and control switch

Position see chapter 2.1.1 - "Functional and operating elements"

The main switch is used to disconnect the freeze-dryer from the mains power supply. As a result, all of the automatic valves will be closed and all of the units will be switched off. A running process will be interrupted and can be resumed at a later time.

In order to disconnect the control circuit from the power supply as well, the control switch must also be switched off!

Two-hand control of the manually operated shelf movement

see also chapter 6.6.1 - "Manually operated shelf movement"

If the loading door is open, the movement button for moving the shelves up or down must be pressed together with the "Release" safety button in order to eliminate the risk of crushing between the shelves (two-hand control).

The movement will stop immediately when the movement button or the "Release" button is released.

Special equipment: Door contact switches

This safety device is installed in combination with the operating mode "Inertisation" (see chapter 6.7.1.3 - "Main window "Options"") or "Aeration, stoppering, storage" (see chapter 6.7.3.1 - "Creating a program").

The status of the loading door is monitored by the door contact switches. This ensures that, when the door is opened in the "Inertisation" mode, the supply with nitrogen is stopped. In the "Aeration, stoppering, storage" mode, the automatic movement of the shelves will be interrupted when the door is opened.

3.9 Procedures in the event of hazards and accidents

Hazardous electrical incident:

- Switch the main switch and the control switch of the freeze-dryer off in order to interrupt the power supply completely.

Fire:

- A fire in the electrical control system must be extinguished with a CO₂ fire extinguisher!
- Burning oil must be extinguished with a CO₂ fire extinguisher or powder fire extinguisher!

Unconsciousness/paralysis due to nitrogen or refrigerant:

- While ensuring your **own safety** (e.g. self-contained breathing apparatus) remove the affected persons to fresh air. Keep them warm and calm. **Get medical attention immediately!** In case of respiratory arrest, give artificial respiration.

Electric shock:

- While ensuring your **own safety**, interrupt the circuit as quickly as possible (mains switch at the right side of the freeze-dryer). Keep the affected persons warm and calm. **Get medical attention immediately!** Check consciousness and breathing continuously. In the case of unconsciousness or lack of normal breathing, perform cardiopulmonary resuscitation (CPR).

Burns:

- Cool small-area burns (e.g. finger) immediately with cold water for approximately 2 minutes.
- Do not cool if larger areas of the body surface are burnt since there is a risk of hypothermia.
- Cover the burns loosely and in a sterile manner (e.g. with sterile dressing).
- Keep the affected persons warm and calm.

Chemical burns:

- **Eyes:**
Rinse the eyes thoroughly with plenty of water with the lid gap wide open for at least 15 minutes (eyewash bottle). **Consult an ophthalmologist immediately** even if there are no immediate symptoms. If possible, continue rinsing the eyes during the transport to the ophthalmologist.
- **Respiratory tract:**
While using a **suitable breathing apparatus**, remove the affected persons to fresh air. Keep them warm and calm. **Get medical attention immediately!** In case of irregular breathing or respiratory arrest, give artificial respiration.

3 Safety

- Skin:
Wash with plenty of water. Remove contaminated clothing. Rinse the affected skin areas under flowing water for at least 10 minutes. **Get medical attention immediately!**
- Oesophagus:
Do not put anything into the mouth of an unconscious person. Wash the mouth out with water, If the person is conscious: Give the affected person plenty of water to drink (2 glasses maximum). Do not induce vomiting. In case of spontaneous vomiting, keep the head of the affected person lying on his/her stomach low in order to prevent any liquid from entering the respiratory tract. **Get medical attention immediately!**

IF IN DOUBT; CALL AN EMERGENCY PHYSICIAN!

3.10 Maintenance and cleaning of the freeze-dryer

The substances and materials that are used must be properly handled and disposed of (Please refer to the safety data sheets!). This applies particularly to

- the handling of solvents, lyes, and acids,
- the changing and topping-up of operating supplies.

Compliance with the national rules and regulations must be ensured.

3.11 Additions or conversions of the freeze-dryer

Additions or conversions of the freeze-dryer require the written approval by Martin Christ Gefriertrocknungsanlagen GmbH.

3.12 Measures to be taken to ensure safe operation of the freeze-dryer

In order to ensure the safe operation of the freeze-dryer, please comply with the following points prior to every freeze-drying process:

Set-up, connection and operation

- Ensure that the freeze-dryer was set up and connected properly (see chapter 5 - "Set-up and connection").
- Check the freeze-dryer and the accessories before every start-up for any visible signs of damage.
- Do not hit or move the freeze-dryer during its operation.
- Do not lean against or rest on the freeze-dryer during its operation.
- Stop the freeze-dryer immediately in the event of a malfunction. Eliminate the malfunction (see chapter 7 - "Malfunctions and error correction") or contact the after-sales service of Firma Martin Christ Gefriertrocknungsanlagen GmbH (see chapter 7.3 - "Service contact").
- Ensure that all repairs are performed only by authorised and specialised personnel.

Fire prevention

- Fuses protect certain electrical circuits within the freeze-dryer against over-current conditions. Always use fuses of the same type and rating.

Safety area

- Maintain a safety distance of at least 30 cm (12 inches) around the freeze-dryer.
- Do not store any dangerous goods in the safety area of the freeze-dryer.
- Do not place any dangerous material, e.g. glass vessels containing liquid substances, within the safety area of 30 cm around the freeze-dryer. Spilled liquids may get into the freeze-dryer and damage the electrical or mechanical components.
- Do not stay in the safety area longer than what is absolutely necessary for the operation of the freeze-dryer.

Accessories

- Do not use the freeze-dryer with accessories that shows signs of damage.
- Only use accessories that have been approved by the manufacturer (except for commercial vessels made of glass or synthetic materials). We explicitly warn against the use of equipment of poor quality! Breaking glass or bursting vessels can cause dangerous situations.

3 Safety

Handling hazardous materials

- The generally applicable regulations for handling flammable substances in laboratories / workplaces must be observed.
- During sample preparation, loading and unloading of samples and defrosting, appropriate safety precautions must be observed.
- Depending on the used solvent, hot gas defrosting should be avoided.
- Caution when handling hazardous materials such as strong acids or bases, radioactive substances and volatile organics: If such substances are spilled, they must be cleaned up immediately.
- If a sample with hazardous materials such as strong acids or bases, radioactive substances or volatile organics is spilled inside a chamber, they must be cleaned up immediately.
- Caution when handling solvents: Keep sources of ignition away from solvents.
- When using flammable or hazardous solvents, the vacuum pump must be vented to or operate inside a fume hood.

3.13 Remaining hazards

All Christ freeze-dryers were built state-of-the-art and according to the accepted safety rules. Danger to life and limb of the operator, or of third parties, or impairments of the units or other material assets, however, cannot be completely excluded when the units are being used.

Use the freeze-dryer

- only for the purpose that it was originally intended for (see chapter 1.3 - "Intended use") and
- only if it is in a perfect running state.
- Immediately eliminate any problems that can affect safety.

4 Storage and transport

4.1 Dimensions and weight

Epsilon 2-10D LSCplus	
Height:	1,303 mm
Width:	1,190 mm
Depth:	866 mm + 100 mm vacuum connection
Weight:	approx. 665 kg

4.2 Storage conditions

In order to ensure the protection against mechanical and climatic influences, the guidelines of the German Federal Association for Wooden Packages, Pallets, and Export Packaging (Bundesverband Holzpackmittel, Paletten, Exportverpackung e.V.), the so-called HPE packaging guidelines, must be applied when packing and storing the freeze-dryer.

The storage must be:

- dust-free
- dry
- free from excessive temperature fluctuations
- free from a mechanical load.

4.3 Unpacking the freeze-dryer



WARNING

General risk of injury

Among the general hazards when unpacking or during the transport of the freeze-dryer are impact hazards, crushing hazards, grazing hazards, cutting hazards, etc.

This may lead to severe injuries.

- Comply with the fundamental health and safety rules and regulations as well as with the rules and regulations for the prevention of accidents!
- Wear personal protective equipment (safety shoes, work gloves, and hardhat)!



DANGER

Risk of injury caused by the uncontrolled movement of loads

Freeze-dryer components that are not properly fastened or secured may shift, or fall over.

- Take the centre of gravity of the load in consideration (off-centre)!
- Prior to transporting the freeze-dryer, read this chapter of the operating manual thoroughly!

4 Storage and transport



CAUTION

The freeze-dryer Epsilon 2-10D LSCplus weighs approx. 665 kg!

The freeze-dryer is packaged in a wooden crate.

- After opening the packaging, take out the accessories.
- Remove the packaging material.
- Remove the side walls of the crate.
- Lift the freeze-dryer upwards with a lifting device.
- Retain the packaging for any possible future transport of the freeze-dryer.

4.4 Transport



WARNING

General risk of injury

Among the general hazards during the transport of the freeze-dryer are impact hazards, crushing hazards, grazing hazards, cutting hazards, etc.

This may lead to severe injuries.

- Comply with the fundamental health and safety rules and regulations as well as with the rules and regulations for the prevention of accidents!
- Wear personal protective equipment (safety shoes, work gloves, and hardhat)!



DANGER

Risk of injury caused by the uncontrolled movement of loads

Freeze-dryer components that are not properly fastened or secured may shift, or fall over.

- Take the centre of gravity of the load in consideration (off-centre)!
- Prior to transporting the freeze-dryer, read this chapter of the operating manual thoroughly!



CAUTION

The freeze-dryer Epsilon 2-10D LSCplus weighs approx. 665 kg!



NOTE

Freeze-dryers of the type Epsilon 2-10D LSCplus that are filled with natural, flammable refrigerants are not approved as air freight!

- Use suitable packaging for the transport, and if at all possible, the original packaging.
- Install all transport safety devices (see chapter 4.4.1 - "Transport safety devices").

On-site transport

The freeze-dryer comes with castors. It can be pushed by a suitable number of persons over short distances. Over longer distances, it should be transported by way of suitable lifting equipment (e.g. forklift truck).

Special equipment: Stainless steel bellow at the hydraulic cylinder

If the freeze-dryer is equipped with a stainless steel bellow at the hydraulic cylinder, an underrun protection device for the hydraulic system is installed at the bottom of the unit chapter 2.1.1 - "Functional and operating elements". When lifting the freeze-dryer, the underrun protection device must be positioned between the forks of the lifting device.

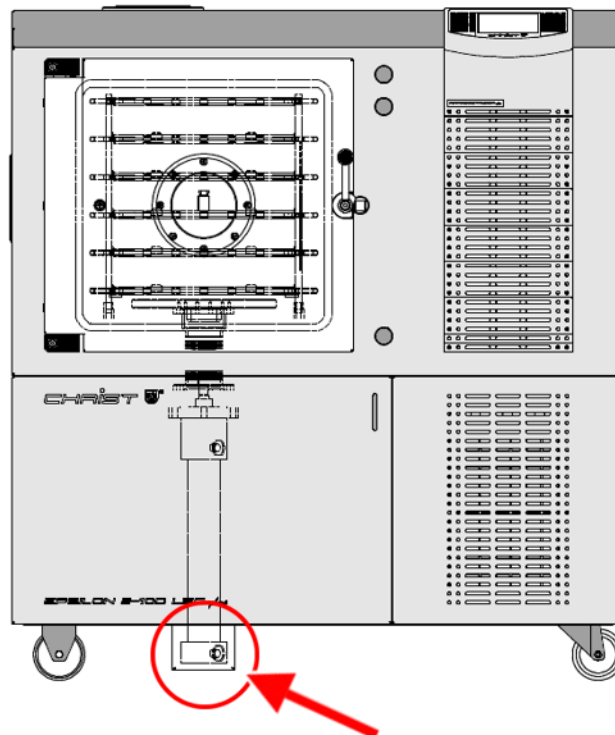

Fig. 12: Underrun protection device of the hydraulic cylinder

4.4.1 Transport safety devices

The following transport safety devices must be removed prior to start-up:

- Remove the polystyrene blocks between the shelves.
- Unscrew the sealing cap of the expansion vessel of the heat transfer medium and install the drying cartridge (adsorption filter) (see chapter 5.2.9 - "Drying cartridge (adsorption filter)").
- Install the vacuum sensor (see chapter 5.2.8 - "Vacuum sensor").



Prior to any transport, the transport safety devices must be reinstalled.

5 Set-up and connection

5 Set-up and connection



WARNING

Risk of injury caused by poor accessibility of the freeze-dryer

In cramped spaces or locations with poor accessibility, sharp edges and corners may protrude into the work area.

This may lead to injuries caused by impact hazards or grazing hazards.

- Ensure that the freeze-dryer is set up freely accessible!
- Comply with the fundamental health and safety rules and regulations as well as with the rules and regulations for the prevention of accidents!



WARNING

Risk of injury caused by escaping media or other consequences of improper connections

Improper connections may lead to problems, e.g. a hazardous electrical incident or the escape of media (depending on the configuration of the freeze-dryer e.g. hot water, nitrogen, hydrogen peroxide), at a later time during the operation of the freeze-dryer.

This may lead to severe damage to health or even life-threatening injuries.

- Ensure that the supply and disposal connections are established by competent and specialised persons under consideration of the corresponding connection specifications (see the instructions in this chapter and chapter 10 - "Technical data")!
- The connections to the on-site pipes must be force-free and torque-free!

5.1 Installation site

Operate the freeze-dryer only in closed and dry rooms.



NOTE

Refrigeration problems of the freeze-dryer are often caused by insufficient conditions at the location of use. This is why compliance with the following conditions is absolutely mandatory!

- Ensure sufficient ventilation. Do not place any paper, cloth, or similar material behind or under the unit, since otherwise the air circulation will be impaired.
- Keep a safety distance of at least 30 cm around the freeze-dryer so that the vents in the unit remain fully effective.
- The ambient temperature must be in the range of +5°C to +25°C. A potential night-time setback of the air conditioning system must be taken into consideration.
- Prevent the room temperature from rising, for example due to closed doors at night.
- Do not subject the freeze-dryer to thermal stress, e.g. by positioning it near heat generators.
- Prevent thermal overload, e.g. caused by other equipment in the direct vicinity of the freeze-dryer.

5 Set-up and connection

- Do not set up the vacuum pump directly next to the heat exchanger (condenser).
- In the case of water-cooled systems, ensure that the water circuit provides a sufficient amount of cooling water.
- Avoid direct sunlight (UV radiation).

5.2 Supply and disposal connections

5.2.1 Power supply

5.2.2 Connection



DANGER

Danger of life caused by electric shock

There is a risk of electric shock when touching current-carrying components.

This may lead to ventricular fibrillation, cardiac arrest, or respiratory paralysis.

- Only qualified electricians are authorised to perform work on the electrical system of the freeze-dryer!
- The electrical equipment of the freeze-dryer must be checked at regular intervals by a qualified electrician!

Defects such as loose connections or burnt cables must be eliminated immediately.



DANGER

The operating voltage on the name plate must correspond to the local supply voltage

Christ freeze-dryers are units of safety class I. Epsilon 2-10D LSCplus units have a five-wire power cord with a 5-pin CEE plug (see chapter 10 - "Technical data").



CAUTION

Prior to connecting the unit to the power supply system, check the rotary field at the electrical outlet with a suitable measuring instrument:

The rotary field must be clockwise!

5.2.2.1 Customer-provided fuses

Typically, the freeze-dryer must be protected with 16 A fuses that are to be provided by the customer.

5 Set-up and connection

5.2.3 Aeration



DANGER

Risk of injury caused by bursting of the chamber

The double chamber is designed for vacuum. It is not a pressure vessel! In the event of a malfunction, an impermissible excess pressure may build up in the chamber, which may cause the chamber to burst.

This may lead to life-threatening injuries.

- Do not use the freeze-dryer when it is pressurised (excess pressure)!
- We strongly recommend installing a pressure relief device (e.g. a safety valve or rupture disc) with a sufficient rating.

The freeze-dryer is equipped with one aeration valve (see chapter 2.1.1 - "Functional and operating elements").

After the freeze-drying process, the aeration valve is used for aerating the chambers to atmospheric pressure so that the loading door can be opened in order to remove the product.

Usually, the ambient air is used for the aeration. However, the chamber can also be aerated with an inertisation medium (e.g. nitrogen) via the hose connector of the aeration valve.

5.2.3.1 Special equipment: Precision control needle valve for air injection

In addition to the aeration valve, a precision control needle valve is also installed (position see chapter 2.1.1 - "Functional and operating elements"). The precision control needle valve is used to pre-adjust the volume flow. If the actual value is below the preselected vacuum value, this valve will open briefly, thereby ensuring a constant vacuum in the freeze-dryer.



NOTE

The precision control needle valve is pre-adjusted at the factory. Using the precision control needle valve, the volume flow must be pre-adjusted according to the chamber pressure at which the freeze-drying process is to be performed. The lower the desired chamber pressure is, the lower the volume flow has to be pre-adjusted in order to prevent the vacuum from oscillating or from showing regular peaks.

Pre-adjusting the volume flow:

We recommend to proceed as follows:

1. Close the precision control needle valve completely by turning the adjusting knob clockwise to the stop (several turns may be needed).
2. Set the vacuum set value to one decade below the desired drying vacuum (Example: If the desired drying vacuum is 1.0 mbar, set the vacuum set value to 0.1 mbar).
3. Start the evacuation of the chamber.
4. When the set vacuum is reached, set the vacuum set value to the desired drying vacuum. The solenoid valve in the gas injection line will be opened after the new value is confirmed.
5. While watching the pressure readings, turn the adjusting knob of the precision control needle valve slowly counter-clockwise until the readings start approaching the new vacuum set value (approx. 1½ ... 2½ turns, depending on the chamber volume). The volume flow is now correctly preadjusted. The approach speed can be increased by opening the needle valve slightly wider, but the readings must not overshoot the new vacuum set value (if needed, the preadjusting procedure has to be repeated).

5.2.4 Drain



WARNING

Risk of poisoning/infection caused by contaminated condensate (defrosting water)

The condensate may contain harmful substances originating from the product.

Contact with the condensate may cause severe damage to health.

- Ensure the environmentally sound disposal of the condensate in compliance with the local rules and regulations!

The freeze-dryer is equipped with one media drain valve (see chapter 2.1.1 - "Functional and operating elements").

It is used to drain off the condensate and the defrosting water.

- Connect the drain hose (included in the scope of supply) to the hose connector.
- Place a collecting vessel under the unit.

The hose must be laid with a continuous slope and the end of the hose must always be above the liquid level in the collecting vessel. This prevents water and dirt residues from being sucked into the ice condenser chamber if there is negative pressure when the media drain valve is opened.

5.2.5 Special equipment - water cooling system: cooling water inlet and outlet

The refrigeration circuits require a sufficient supply with cooling water. The cooling water inlet connection (see chapter 2.1.1 - "Functional and operating elements") must be connected to the water supply network or to the corresponding connector of a recooling system. The cooling water outlet connection must be connected to the sewage system or to the corresponding connector of the recooling system.



The cooling water inlet and outlet must be properly connected to the water supply or recooling system (in accordance with the labels on the freeze-dryer). If they are not connected properly (reverse connection), there will be no flow.



When connecting the cooling water supply, it must be taken into consideration that, due to the cooling water control valves, the water cannot flow at all or at least not freely through the refrigeration system. It is only when the freeze-dryer is in operation that the flow will be enabled.

The customer-provided cooling water feed flow line must be equipped with a shut-off valve since, depending on the setting, the cooling water control valves do not completely close when the freeze-dryer is switched off.

Optionally, the cooling water request signal, for controlling the customer-provided shut-off valve, can be connected via a floating contact in the switch cabinet.

5 Set-up and connection

The cooling water demand is controlled automatically by the cooling water control valves in line with the load of the refrigeration units. For preadjustment, the cooling water control valves are equipped with an adjusting knob which can be adjusted with the aid of a screwdriver. The preadjustment must ensure that, under the present cooling water conditions (pressure and temperature), the pressure on the high-pressure side of the refrigeration circuit is approximately 13 bar under no-load conditions. The pressure difference (Δp) must be 1.5 bar at a minimum (see chapter 10 - "Technical data").

- 1 Pressure gauge
- 2 Cooling water control valve

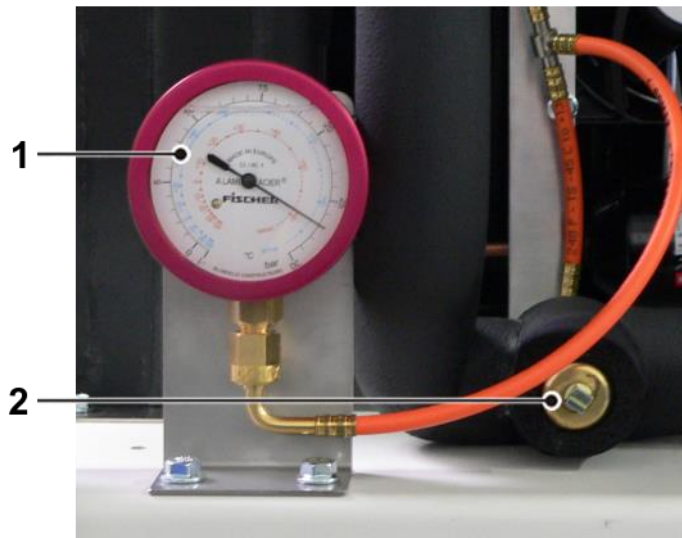

Fig. 13: Cooling water control valve

If the supply with cooling water is insufficient, the pressure inside the refrigeration system will rise and the refrigeration unit will be switched off via the overpressure switch. The error will be indicated by the control system of the freeze-dryer.

Please contact our specialists if the cooling water temperature is higher than +20°C.

5.2.6 Vacuum pump



WARNING

Risk of poisoning/infection caused by vacuum pump exhaust gases

The exhaust gases of the vacuum pump may contain harmful substances originating from the product.

Inhalation may cause severe damage to health.

- Use the freeze-dryer only if it is equipped with a pipe that is properly connected to the outlet of the vacuum pump/exhaust filter (oil mist separator) and led to the outside via the roof!
- Depending on the product that is dried in the freeze-dryer, it may be necessary to install a suitable filter system in the exhaust gas pipe!
- Compliance with the local rules and regulations concerning the protection of the environment must be ensured!



NOTE

Please refer to the separate operating manual of the vacuum pump and the exhaust filter (oil mist separator)!

The oil mist that escapes when the pump is in operation must be retained or carried off by way of an exhaust filter (oil mist separator).

- We strongly recommend using an oil mist separator. This filter prevents air pollution by oil mist that is emitted more or less strongly by the pump depending on the working pressure.
- Use the freeze-dryer only if it is equipped with a pipe that is properly connected to the outlet of the oil mist separator and led to the outside via the roof. The hose must be laid so that the condensate cannot flow back into the pump. In the case of upward leading hoses, we recommend using a separator (Woulfe's bottle or wash bottle).

5 Set-up and connection

5.2.7 Pressure control valve

The pressure control valve is integrated in the suction pipe between the vacuum pump and ice condenser chamber. During certain, specified process phases, it interrupts the volume flow to the vacuum pump (see chapter 2.2.1 - "General information on freeze-drying")



CAUTION

The pressure control valve must be installed in the direction of the volume flow in the indicated installation direction (see illustration below)!

- 1 Installation direction of the pressure control valve

1

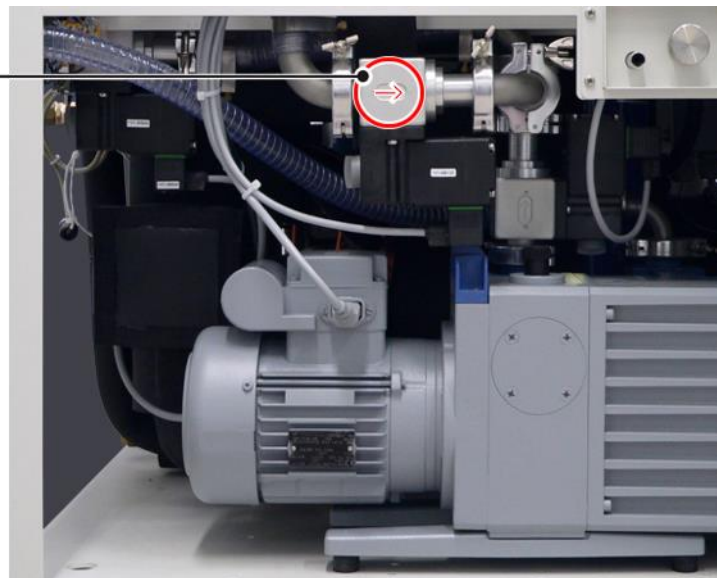

Fig. 14: Vacuum pump with pressure control valve

5.2.8 Vacuum sensor

Please refer to the separate operating manual of the vacuum sensor!

As standard, the freeze-dryer is equipped with a Pirani vacuum sensor (e.g. Thyracont VCP63, position see chapter 2.1.1 - "Functional and operating elements"). If solvent-containing products are to be processed, the freeze-dryer must be equipped with special equipment, including capacitive vacuum sensors (e.g. Pfeiffer CMR 363) and pressure sensors (e.g. Jumo dTrans p30).



If only capacitive sensors are used, comparative pressure measurement is not possible.

Installation of the vacuum sensor

In order to protect the vacuum sensor against transport damage, it comes supplied in its original packaging. Prior to commissioning the freeze-dryer, the sensor must be installed.

- Switch the unit off by actuating the mains power switch.
- The screws for the left-hand side panel are located at the back of the unit. Loosen the screws and take the panel off diagonally towards the back.
- Take the vacuum sensor out of its original packaging and fasten it to the connector with a clamping ring (DIN16KF) and a centring ring (both included in the scope of supply).
- Plug the connector (installed on the unit) onto the vacuum sensor and hand-tighten the screw on the connector.



It is absolutely essential to comply with the manufacturer's instructions in the separate operating manual of the vacuum sensor!



The vacuum sensor comes supplied in a calibrated state.

After power-on, the vacuum sensor needs a few minutes to reach its operating temperature.

5 Set-up and connection

5.2.9 Drying cartridge (adsorption filter)

The drying cartridge prevents the air humidity from being absorbed by the heat transfer medium.

During the transport of the freeze-dryer, the drying cartridge at the filler neck of the heat transfer medium is removed from the filler neck of the heat transfer medium. Prior to commissioning the unit, it must be installed.

- Remove the sealing cap (1) from the valve.
- Connect the supplied adapter (5) together with the drying cartridge (4) to the valve (2).
- Open the valve (2) by turning it anti-clockwise up to the stop.

- 1 Sealing cap
- 2 Valve
- 3 Connection of the expansion vessel (inside the unit)

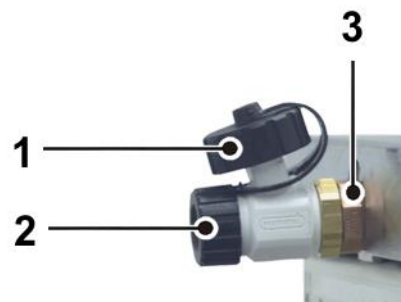

Fig. 15: Valve with sealing cap for transport

- 4 Drying cartridge (adsorption filter)
- 5 Adapter

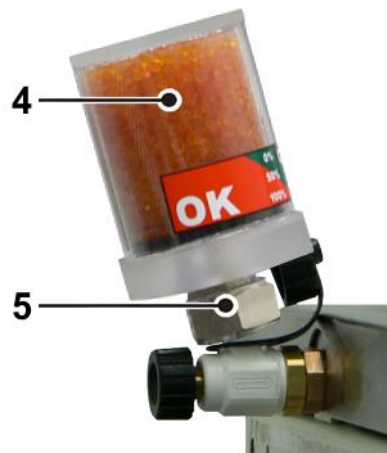

Fig. 16: Valve with drying cartridge (adsorption filter)

Special equipment: Stainless steel bellow at the hydraulic cylinder

If the freeze-dryer is equipped with a stainless steel bellow, a second drying cartridge is located under the drying chamber (see chapter 2.1.1 - "Functional and operating elements"). This drying cartridge is not removed during the transport.



The silica gel of the drying cartridges has a limited adsorption capacity. If the colour of the silica gel changes from orange to green (see label on the drying cartridge), the drying cartridge must be replaced (Christ order no. 610 993).

6 Operation

6.1 Initial start-up



Risk of injury caused by consequences of transport damage, or improper connections (e.g. escaping media).

Leaks after the transport, set-up, and connection of the freeze-dryer may lead to problems, e.g. the escape of media (depending on the configuration of the freeze-dryer, e.g. refrigerant, heat transfer medium, hydraulic oil, nitrogen, hydrogen peroxide, etc.), at a later time during the initial start-up of the freeze-dryer.

This may lead to severe damage to health or even life-threatening injuries.

- Prior to the initial start-up of the freeze-dryer, all of the supply and disposal connections must be checked for leaks by specialised persons.

6.2 Installation of accessories

The accessories must be completed in accordance with the drying method that is applied as well as in accordance with the scope of supply.

6.3 Preparation

The ice condenser chamber must be clean and dry.

- Remove any water residues from the preceding run.
- Close the aeration valve and the media drain valve.
- Ensure that all of the valves of the accessories are closed.
- Switch the vacuum pump on.

6.4 Switching the freeze-dryer on



The freeze-dryer is equipped with a main switch and a mains power switch (see chapter 3 - "Safety"). The main switch establishes the mains power supply and the control switch supplies the control system of the freeze-dryer with power.

- Actuate the main switch.
- Actuate the control switch.

The LSCplus control unit performs a self-test and an initialisation. This may take several seconds.

- Follow the safety instructions and hazard warnings (see chapter 3 - "Safety")!

6 Operation

6.5 Loading door



DANGER

Risk of crushing caused by the movement of the loading door

Due to its relative high mass, the movement of the loading door can hardly be slowed down or stopped.

There is a risk of crushing of body parts between the door and the front of the chamber.

- Move the loading door slowly holding the door handle when opening or closing it. Do not hold the door leaf by its edge!
- Lock the door by turning the door handle!

After the drying chamber has been loaded, the loading door is closed and pressed tightly against the flange of the drying chamber with the aid of the locking handle. The locking handle is now in a perpendicular position with regard to the door edge (see figure below). When a vacuum builds up inside the drying chamber during the drying process, the loading door will be pulled closer to the flange of the drying chamber. As a result, the locking handle will be loosened and it will hang down loosely.



NOTE

If the locking handle does not hang down perpendicularly when the loading door is closed, it can be readjusted. To do so, loosen the hexagon socket screw (size 8), readjust the locking handle, and retighten the screw.



CAUTION

Do not tighten the locking handle when there is a vacuum inside the drying chamber. During the aeration, the pressure on the locking handle will increase to such an extent that the loading door may be damaged beyond repair!



Fig. 17: Example of a door locking system of the loading door; here: door stop (left side)

Radiation Shield film for loading doors made of acrylic glass

Loading doors made of acrylic glass have a special, transparent film on the exterior side of the acrylic glass door. This film reduces the transfer of radiant heat onto the product and ensures homogeneous freeze-drying results. In addition, it reduces any potential thawing effects and ensures safe and quick drying close to the freezing point.



Comply with the cleaning instructions concerning the film (see chapter 8.1.3.1 - "Lamination of the loading door with a special film")!

Special equipment: Solvent Shield film for loading doors made of acrylic glass

The acrylic glass door of the freeze-dryer can additionally be equipped with a special, transparent and chemical-resistant film that protects the interior side of the acrylic glass door against aggressive chemicals. As a result, solvents such as acetonitrile or alcohols, which are very common in freeze-drying applications, can be used without the need for a stainless-steel door. The product remains perfectly visible during the freeze-drying process, thereby enabling unrestricted observation of the product.



Comply with the cleaning instructions concerning the film (see chapter 8.1.3.1 - "Lamination of the loading door with a special film")!

6.6 Hydraulic system

6.6.1 Manually operated shelf movement

**DANGER****Risk of crushing caused by the movement of the shelves**

The shelves can be moved upwards/downwards by hydraulic force. In addition, the shelves may sag down in an uncontrolled manner in the event of a malfunction of the hydraulic system.

There is a risk of crushing of body parts under and between the shelves.

- Do not reach into the chamber while the shelves are in movement!
- Do not manipulate, remove, or disable the two-hand-control of the shelf movement system or the door contact switch (if available) in any way!

By means of the two push-buttons "Up" (1) and "Down" (2) it is possible to move the shelves vertically for loading / unloading, stoppering product vials inside the drying chamber as well as for maintenance purposes. The movement of the shelves is only possible if the "Up / Down" buttons are pressed simultaneously (< 0.5 sec) with the push-button "Release" (3) to avoid injuries ("two-hand control").

6 Operation



Fig. 18: Shelf movement push-buttons (example illustration)

In order to move the shelves, the respective push-button has to be kept pressed in combination with "Release". The shelves will move continuously until one of the buttons is released or the upper or lower hard stop position has been reached.



In order to seal the product vials by means of the hydraulic shelf movement facility, the shelves must be **completely loaded with identical vessels** to avoid damaging shelves and guiding rods as well as breakage of vessels. For partially loaded shelves use empty vessels with stoppers put in or spacers (according to the height of the vials with stoppers) to distribute the force of the hydraulic ram. Appropriate spacers are available on request.

6.6.2 Special equipment: stainless steel bellow for the hydraulic cylinder

The stainless steel bellows shields the drying chamber from the hydraulic cylinder. Particularly when drying in dishes, product residues may remain inside the chamber after the freeze-drying process. The stainless steel bellows prevents these residues from depositing on the oil film of the hydraulic cylinder.

6.6.3 Special equipment: changing the distance between the shelves

When the shelves are in the drying position, their lateral extensions rest on different steps of the stepped plates on the left and right of the shelves. These stepped plates, which are permanently connected to the guide rods of the shelf system (see the following illustration, item 1), result in a distance of 59 mm between the individual shelves. This distance can be changed by installing stepped plates with a different step height (item 2) over the permanent plates. However, changing the step height also changes the number of shelves that can be used (see chapter 10 - "Technical data", table "Shelves").

Changing the stepped plates

To install or change the stepped plates, the shelves must be moved up to their upper end position in order to provide access to the drying chamber (see chapter 6.6.1 - "Manually operated shelf movement").



DANGER

Risk of crushing caused by the movement of the shelves

The shelves can be moved upwards/downwards by hydraulic force. In addition, the shelves may sag down in an uncontrolled manner in the event of a malfunction of the hydraulic system (e.g. defective hose line).

There is a risk of crushing of body parts under and between the shelves.

- Do not reach into the chamber while the shelves are moving!
- Do not manipulate, remove or disable the two-hand control of the shelf movement system or the door contact switches (if installed)!

- 1 Stepped plate, permanently installed
- 2 Stepped plate with a different step height

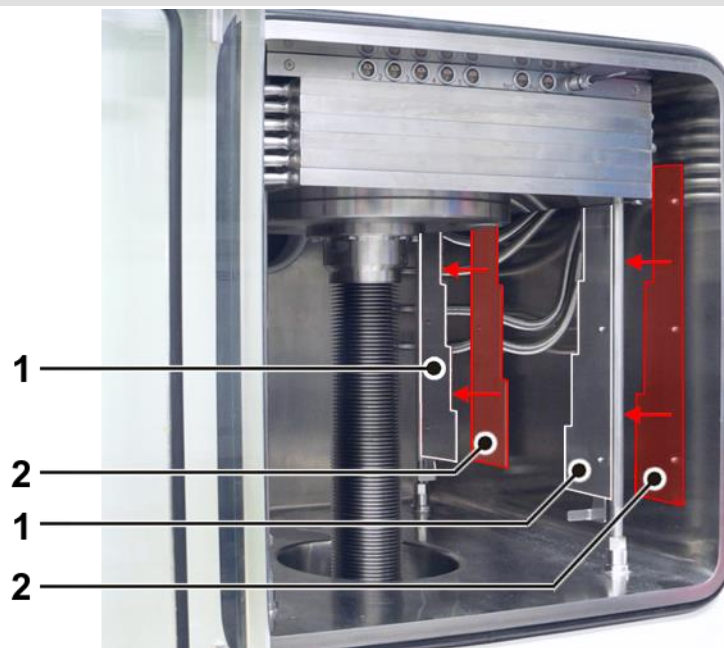

Fig. 19: Installation of the stepped plates (example)

- Check whether you have four stepped plates of the same set (check the labels).

6 Operation



CAUTION

The installation of stepped plates of different sets will damage the shelves, guide rods and stepped plates when the shelves are moved!

- Move the shelves up to their upper end position.
- Outside of the chamber: Prepare the four stepped plates of the same set by removing the nuts from the stud bolts.
- Apply one of the stepped plates (item 2) to the outer face of the corresponding permanent stepped plate (item 1) so that the stud bolts and alignment pins pass through the corresponding holes.
- Secure the stepped plate in place on the stud bolts by screwing on the lower nut.
- Proceed in the same manner with the other stepped plates.
- Move the shelves down to their lower end position so that the middle and upper stud bolts of the stepped plates are accessible.
- Secure the stepped plates completely in place by way of the nuts and check whether the nuts are properly tightened.



Fig. 20: Position of the nuts for installing the stepped plates

The removal is performed in reverse order.

6.7 LSCplus control system

The control system LSCplus (Lyo Screen Control plus) was specifically developed for the control of freeze-drying processes. The clear user interface enables the intuitive operation of the unit.



Fig. 21: Start screen of the LSCplus control unit (example)

6.7.1 User interface

The system is operated via a touch panel, i.e. by touching the buttons on the display. Every button is marked by a frame. Pressing the button activates the associated function. Depending on the function, a dialog box opens, a value can be changed, or a transaction can be confirmed.

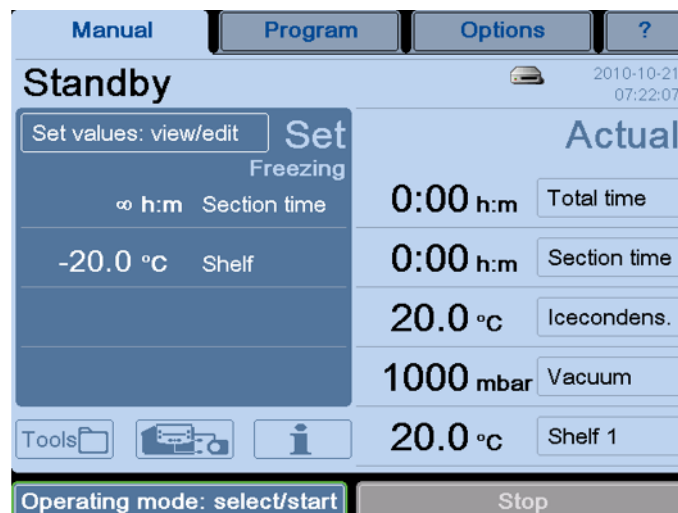

Fig. 22: Buttons are marked by a frame

6 Operation

The user interface is divided into four main windows that can be called up by touching the corresponding buttons:

Manual

This window is also the standard user interface. It is used to control the freeze-drying process manually.

Program

This area is used to create and execute programs for automating the freeze-drying process and for making it reproducible. This function is only available in combination with the programmer module PGMplus option.

Options

This window is used for personalised settings that enable the users to adapt the system as far as possible to their respective area of activity.

?

In this window, the users can find all of the relevant information concerning the control system at a glance. In the event of enquiries at the factory, these data facilitate the assignment and expediting of the processing of the enquiries.

6.7.1.1 Main window "Manual"

This main window shows all of the relevant process data. Here, the individual phases of a freeze-drying process can be controlled manually.

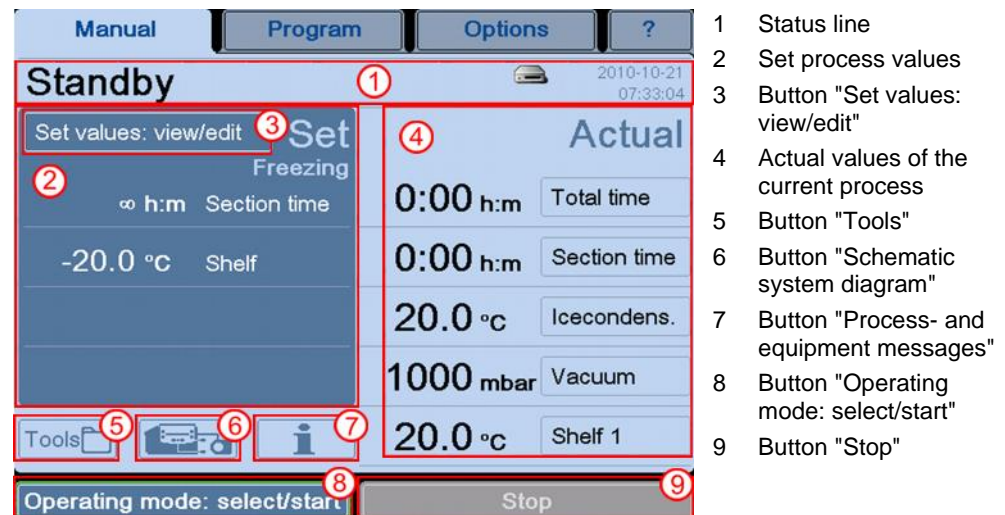







Fig. 23: Overview of the main window "Manual"

Status line (1)

This line shows the operating status of the freeze-dryer as well as the active phase.

The status line also shows the current date and time. The clock is battery-buffered and must be reset after a failure (see chapter 6.7.1.3 - "Main window "Options"", section "Administration").

In addition, the drive symbol provides information concerning the status of the external data storage device or of the network drive. The following symbols are possible:

No symbol	No USB storage device or LAN network connected
	USB storage device connected
	Process recording on a USB storage device active
	Network available, but no network drive connected
	Network drive connected (e.g. LPCplus, LyoLogplus)
	Network drive connected and process recording active

Set process values (2)

In the manual mode, the set values for the individual phases of the freeze-drying process must be entered prior to the start of the process. Value ranges have been saved for the various phases. These value ranges can be displayed in the input window with the aid of the buttons "min" or "max" (see chapter 6.7.2.1 - "Entering set values in the manual mode").

Button "Set values: view/edit" (3)

This button is used to call up the various parameters that can be edited.

Actual values of the current process (4)

This area shows the current process data. The fields can be configured as desired:

- Select the button of the field that is to be adapted. A dialog box opens:

6 Operation

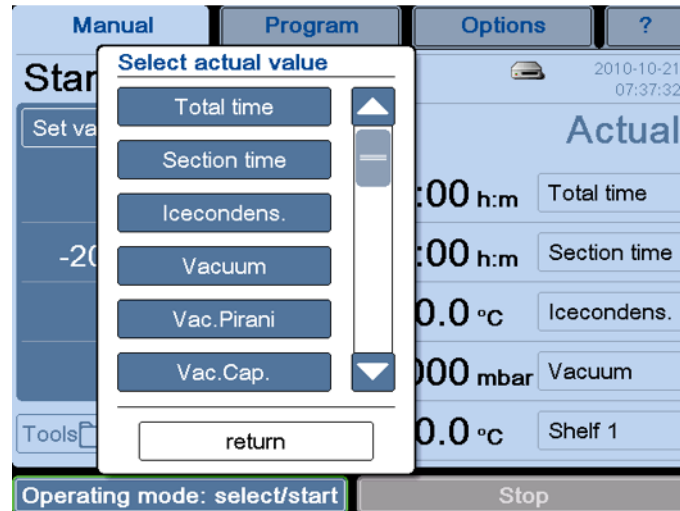

Fig. 24: Dialog box "Select actual value"

- Select the desired configuration or quit the dialog box by pressing the "return" button.

In this way, it is possible to configure a personalised overview of the actual values.

Dialog box "Tools" (5)

This dialog box is used to call up various aids and resources.

Vapour pressure curve above ice

A diagram shows the relationship between the pressure and sample temperature. The pressure and temperature values can be changed by pressing the buttons or by moving the arrows (see figure below, item 1). The other value will be adapted automatically.

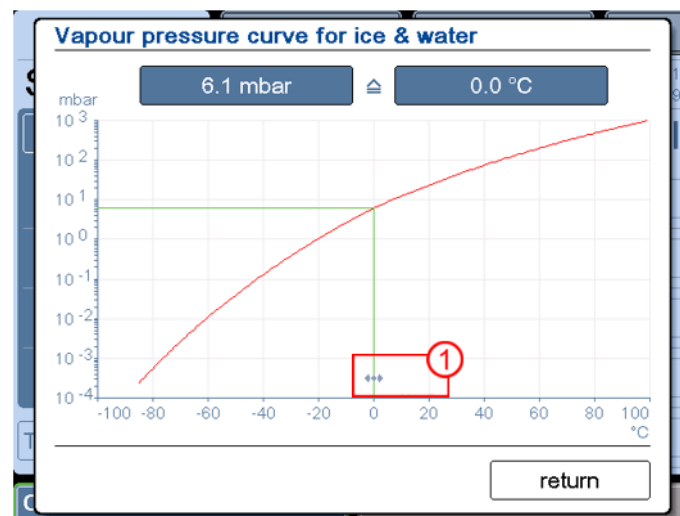

Fig. 25: Dialog box "Vapour pressure curve above ice"

Option: USB process recording (see chapter 6.8 - "Optional extensions and special equipment")

- Select the "Process recording" function in the dialog box "Tools".
- Select the input fields ("Batch data"). A keyboard for the data input will be displayed.
- If necessary, select the "Options" tab, choose between manual or automatic recording, and define a recording interval.
- Press the "return" button in order to close the dialog box.

The process recording will now run in the background.

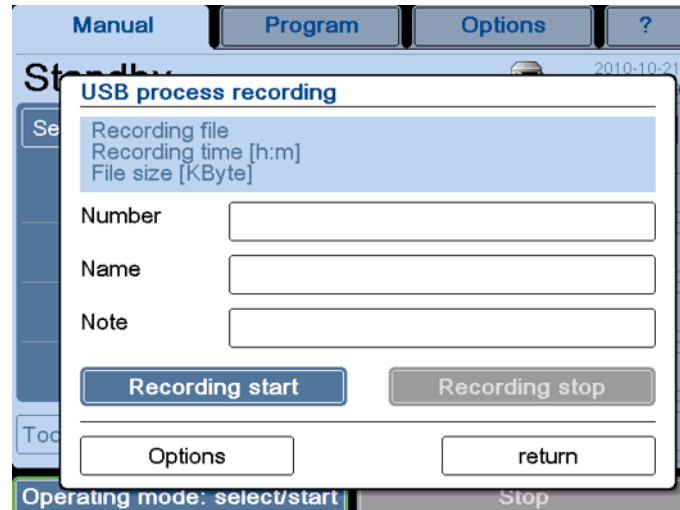

Fig. 26: Dialog box "USB process recording"

Option: Pressure increase test (only with the → double-chamber method)

The → *pressure increase test* can only be performed when the freeze-dryer is equipped with an intermediate valve. The performance is possible in the manual mode as well as in the program mode, Additionally, the pressure increase test can be automatically performed as part of a program (see chapter 6.7.3.1 - "Creating a program").

- Select "Pressure increase test" in the "Tools" dialog box.
- Enter the set values for the duration and maximum pressure increase with the aid of the buttons.
- Start the pressure increase test. The test time will be displayed. After the end of the test, a status message (pressure increase was successful or failed) will be displayed together with the measured values:

6 Operation

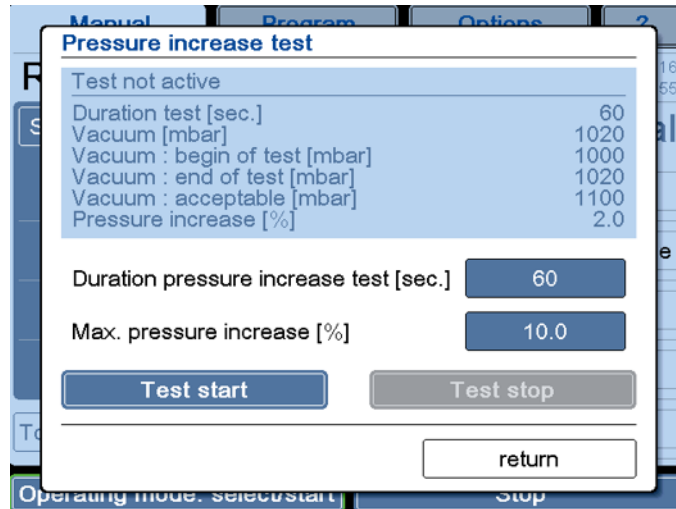

Fig. 27: Dialog box "Pressure increase test"

- The "Test stop" button stops the pressure increase test.

Option: LyoBalance weighing system

If the freeze-dryer is equipped with a LyoBalance weighing system (see chapter 6.8 - "Optional extensions and special equipment"), then the corresponding parameters must be configured in this dialog box.



Please refer to the separate operating instructions of the weighing system!

Dialog box "Schematic system diagram" (6)

Pressing the button "Schematic system diagram" displays a schematic diagram of the system on the left-hand side of the screen, including all the components. Active components are displayed in green. Touching a component calls up its name and → *reference designator*.

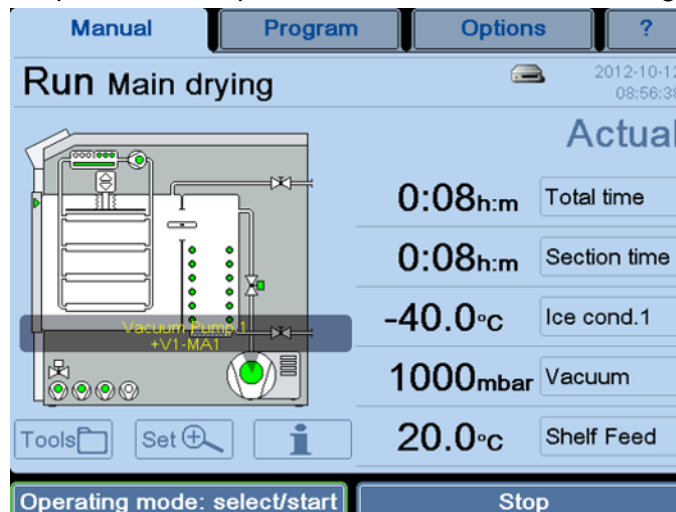

Fig. 28: Schematic system diagram with the name and reference designator of the component

Dialog box "Process and equipment messages" (7)

This dialog box shows and saves all of the error messages and other messages. In the event of an error or message, the window "Process and equipment messages" will open automatically. In addition, a sound signal is emitted until the error is acknowledged.

Malfunctions are divided into three categories:

- Red: error messages
- Orange: process messages
- Yellow: general messages

The representation of the message provides information on its current status. A double frame around a message means that the error has not been eliminated yet. The colour of the button "quit" changes from blue to grey once the message has been acknowledged.

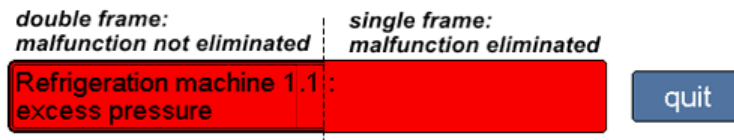
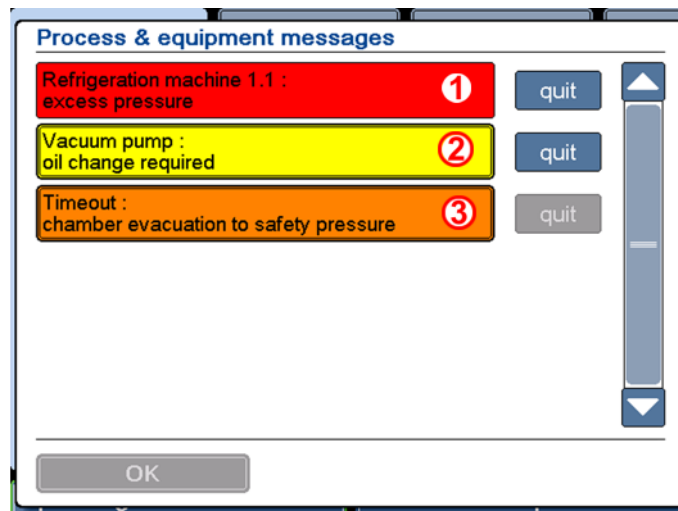

Fig. 29: Representation of an error message

The advantage of this system is that malfunctions that occurred during the night can be discovered the next day even if the cause of the malfunction has already been eliminated.

The dialog box cannot be quit until all of the messages have been acknowledged.

If a message has been acknowledged although the malfunction has not been eliminated, the button "Process and equipment messages" will be displayed in the respective colour of the malfunction in the main window.



- 1 The malfunction has been eliminated, but the message has not been acknowledged yet
- 2 The malfunction has not been eliminated and the message has not been acknowledged yet
- 3 The malfunction has not been eliminated yet, but the message has been acknowledged

Fig. 30: Dialog box "Process and equipment messages"

6 Operation

Details

Touching the message calls up details concerning the error message:

- Cause of the message,
- Effects of the message,
- Measures to eliminate the error,
- → *Reference designator*,
- Error counter (indicates how often this error has occurred) and the time stamp of the last error message.

Use the arrow keys to call up the individual windows.



The error message text is always followed by an error code. Always indicate the error code in the event of enquiries or service requests!

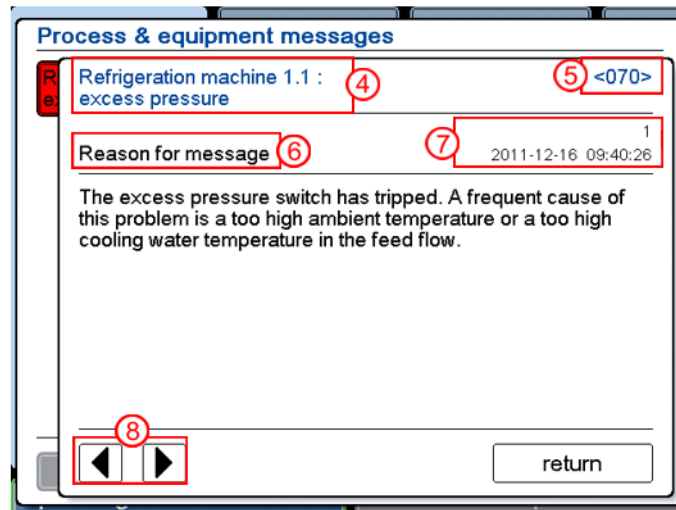

- 4 Error message
- 5 Error code
- 6 Detailed information
- 7 Error counter and time stamp of the last error
- 8 Arrow keys

Fig. 31: Details concerning an error message



The texts of the process and error messages are not included in this operating manual.

You can order these documents from our service department.

Dialog box "Operating mode: select/start" (8)

After the set values have been entered for the process, the process can be started manually with this function (see chapter 6.7.2 - "Manual freeze-drying").

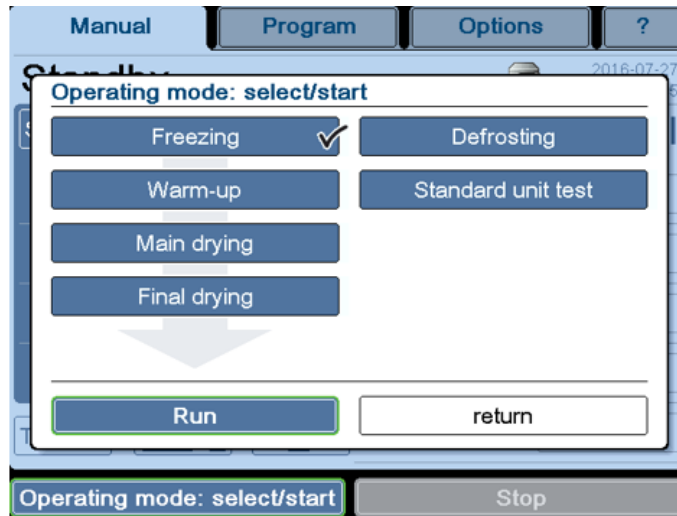

Fig. 32: Dialog box "Operating mode: select/start" (The version of the dialog box that is displayed depends on the equipment of the freeze-dryer.)

Button "Standard unit test"

Apart from the process phases of the freeze-drying process ("Freezing", "Warm-up", "Main drying", and "Final drying") and the operating mode "Defrosting", the button "Standard unit test" is also available. This button opens a selection of various tests with fixed parameters. After consultation with the manufacturer, these tests can be performed in order to check the functionality and processes of the freeze-dryer.



Some of the available tests are also provided in the form of program templates (see chapter 6.7.3.1 - "Creating a program").

6 Operation

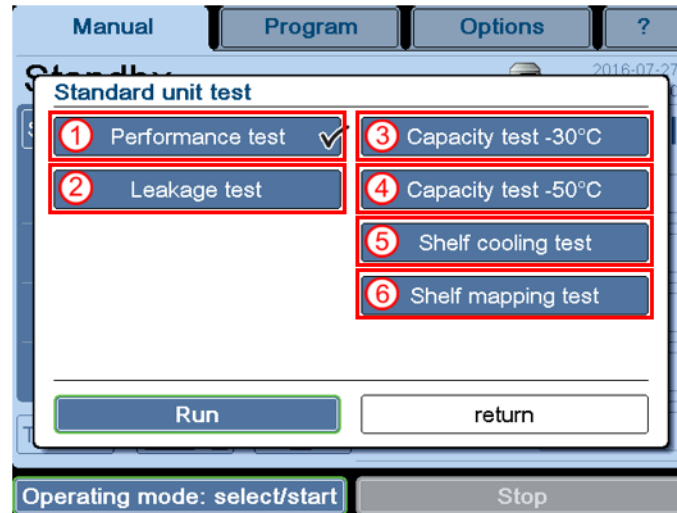

Fig. 33: Possible system tests

Performance test (1)

The performance test is used to determine the following performance parameters:

- vacuum decrease rate
- final vacuum
- minimum ice condenser temperature
- shelf cooling rate
- minimum shelf temperature
- shelf heating rate



Prior to performing a test, ensure that the chamber is dry and unloaded.

Procedure:

- In the main window "Manual", select the button "Operating mode: select/start" – "Standard unit test".
- Select "Performance Test" and start the test via the "Run" button.

The test will be performed. The parameters will be measured at defined points of time, evaluated, and displayed in a dialog box (see the following illustration).

If the freeze-dryer is equipped with the LPCplus SCADA software, the results will be documented in the event list.

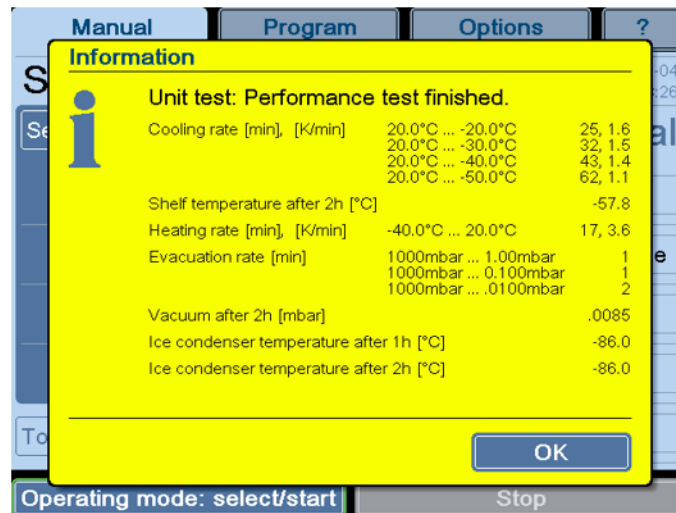

Fig. 34: Results of the performance test

Evaluation:

Please contact the Christ support team for the evaluation of the test run.

Leakage test (2)

The leakage test enables the chamber of the freeze-dryer to be tested for tightness in view of any gaseous or liquid media. Since absolutely tight components simply do not exist, a leak rate is determined.

Procedure:

- In the main window "Manual", open the dialog box "Set values: view/edit" via the corresponding button and then select the button "Leakage test".
- Edit the values "Duration test" (value between 10 min and 18 h) and "Chamber volume" (value see technical data), confirm the new values and return to the main window.
- In the main window "Manual", select the button "Operating mode: select/start" – "Standard unit test".
- Select "Leakage test" and start the test via the "Run" button.

The parameters for the leakage test have been developed by Martin Christ Gefriertrocknungsanlagen specifically for freeze-dryers. In a first step, these parameters (vacuum, ice condenser temperature) must be reached. It is not until the conditions are fulfilled that the pressure control valve closes. Then, the actual leakage test is performed in a second step.

The result will be indicated by way of a dialog box.

If the freeze-dryer is equipped with the LPCplus SCADA software, the results will be documented in the event list.

Evaluation:

The leakage rate that is calculated after the test provides information concerning the tightness of the system. If the threshold value is not reached, the test has been passed. If it is exceeded, the test has been failed.

6 Operation

Capacity test -30°C (3)



The capacity test -30°C is intended for units with one single-stage and one double-stage refrigeration system.

The capacity test -30°C is a freeze-drying program/ for verifying the ice condenser capacity (when the shelves are cooled to -30°C in the "Freezing" phase). For this purpose, the shelves must be loaded.

Procedure:

- Load the shelves evenly with water in dishes for the test. The water quantity must be 2/3 of the maximum ice condenser capacity that is specified for the freeze-dryer.
- In the main window "Manual", select the button "Operating mode: select/start" – "Standard unit test".
- Select "Capacity test -30°C" and start the program via the "Run" button.

In the "Freezing" phase, the shelves are cooled to -30°C. The parameters for the subsequent "Main drying" and "Secondary drying" sections have been configured in such a way that the water will be completely sublimated out of the dishes and bound on the ice condenser after 24 hours.

Evaluation:

The test is passed if the dishes do not contain any water/ice after the end of the process.

Capacity test -50°C (4)



The capacity test -50°C is intended for units with a minimum of two double-stage refrigeration systems.

The capacity test -50°C is a freeze-drying program/ for verifying the ice condenser capacity (when the shelves are cooled to -50°C in the "Freezing" phase). For this purpose, the shelves must be loaded.

Procedure:

- Load the shelves evenly with water in dishes for the test. The water quantity must be 2/3 of the maximum ice condenser capacity that is specified for the freeze-dryer.
- In the main window "Manual", select the button "Operating mode: select/start" – "Standard unit test".
- Select "Capacity test -50°C" and start the program via the "Run" button.

In the "Freezing" phase, the shelves are cooled to -50°C. The parameters for the subsequent "Main drying" and "Secondary drying" sections have been configured in such a way that the water will be completely sublimated out of the dishes and bound on the ice condenser after 24 hours.

Evaluation:

The test is passed if the dishes do not contain any water/ice after the end of the process.

Shelf cooling test (5)



The test is intended solely for freeze-dryers of the type Epsilon 2-6D LSCplus and Epsilon 2-10D LSCplus.

The shelf cooling test is used to check the performance of the shelf cooling system (refrigeration unit 2) during the "Main drying" phase.

The shelves must be empty for the test.

Procedure:

- In the main window "Manual", select the button "Operating mode: select/start" – "Standard unit test".
- Select "Shelf cooling test" and start the test via the "Run" button.

The parameters for the "Main drying" sections have been configured in such a way that refrigeration system 1 only acts on the ice condenser, whereas the shelves are cooled solely by refrigeration system 2.

At the end of the process, a pop-up window with a safety enquiry (confirmation prompt) opens. Following the confirmation of this enquiry, the freeze-dryer will be switched to standby.

Evaluation:

Please contact the Christ support team for the evaluation of the test run.

6 Operation

Shelf mapping test (6)

The shelf mapping test is a freeze-drying program for bringing the shelves to a temperature of +20°C, -40°C, and +40°C for a specific period of time in order to be able to determine the temperature distribution on the shelves for each of these three temperatures with the aid of an external shelf mapping system.

The thermoblocks of the shelf mapping system with the inserted temperature sensors must be distributed evenly on the shelves and connected to the external measurement recorder for the test.

Procedure:

- In the main window "Manual", select the button "Operating mode: select/start" – "Standard unit test".
- Select "Shelf mapping test" and start the program via the "Run" button.
- Start the external measurement recording process at the same time.

During the test, the predefined shelf temperature values are adjusted and maintained constant for a specific period of time in order to keep the temperature distribution in a static state.

At the end of the process, a pop-up window with a safety enquiry (confirmation prompt) opens. Following the confirmation of this enquiry, the freeze-dryer will be switched to standby.

The external measurement recording process can then be stopped.

Evaluation:

Please contact the Christ support team for the evaluation of the test run.

Button "Stop" (9)

Pressing this button stops the current process. The system switches to the standby status.

6.7.1.2 Main window "Program"

In the main window "Program", pre-programmed freeze-drying processes can be loaded and edited and new programs can be created with the PGMplus programmer module.

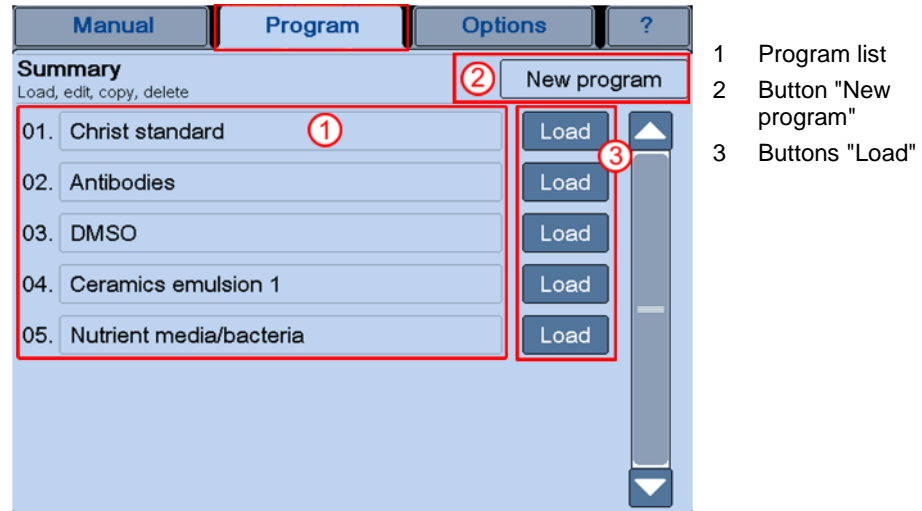

Fig. 35: Overview of the main window "Program"

Program list (1)

After the selection of the main window "Program", an overview of the programs that have already been saved will be displayed. Pressing the button "Load" (3) behind the program name calls up the program data. Programs can be loaded, edited, copied, or deleted (see chapter 6.7.3 - "Freeze-drying with the PGMplus programmer module").

"Dialog box "New program (2)

In this dialog box, new programs can be created either based on an already existing program or completely from scratch (see chapter 6.7.3.1 - "Creating a program").

6 Operation

6.7.1.3 Main window "Options"

The main window "Options" is used to perform fundamental basic settings of the control system in order to adapt it perfectly to the respective area of application of the freeze-dryer.

General

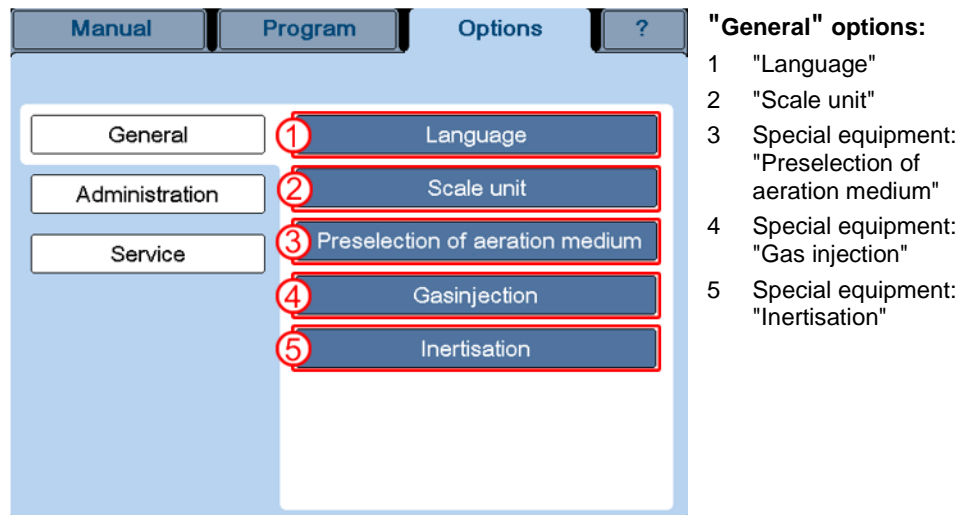

Fig. 36: Overview of the main window "Options/General"

Language (1)

The control system can be used in several languages which can be selected via the dialog box.

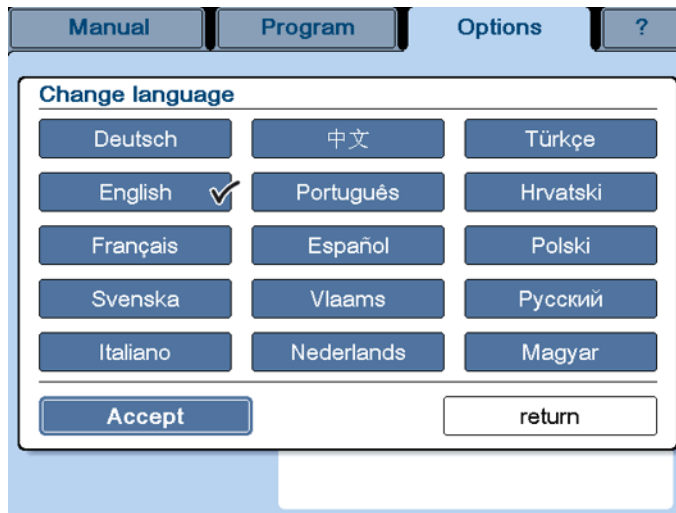

Fig. 37: Dialog box "Change language"

Change scale unit (2)

This dialog box is used to change the unit of measurement for the temperature and vacuum.

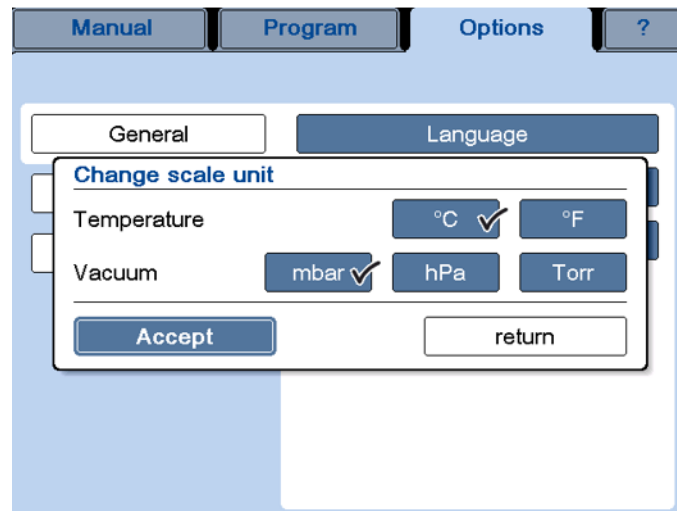

Fig. 38: Dialog box "Change scale unit"

Special equipment: Preselection of the aeration medium (3)

This function can be performed in the manual mode or saved together with a program (see chapter 6.7.3.1 - "Creating a program").

If the freeze-dryer is equipped with an automatic aeration valve and automatic valves for media selection, this dialog box can be used to preselect the medium that is to be used for all of the aeration medium requests in the manual mode (as of the start of the main drying phase) and during the "Aeration" section. The phases "Freezing" and "Warm-up" in the manual mode and the operating modes "Defrosting", "Leakage test", and "Media drain" always use air for aeration.

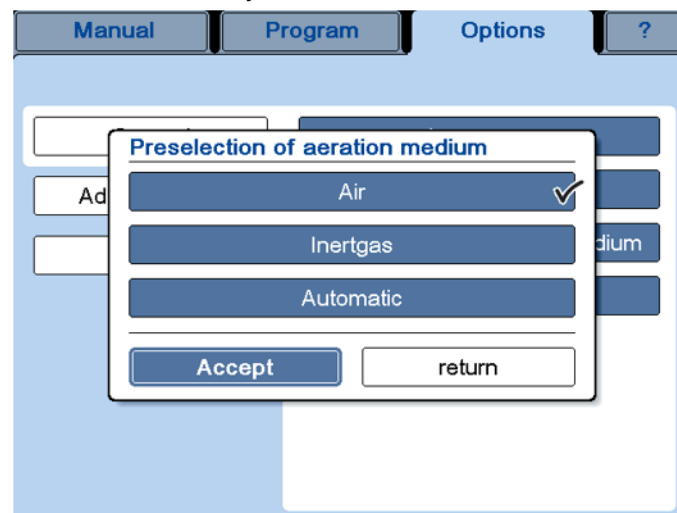

Fig. 39: Dialog box "Preselection of aeration medium"

If the vacuum control system of the freeze-dryer uses a controlled gas inflow (gas injection, bleeding), the preselected medium will be used for this purpose.

6 Operation

The following media preselection settings are possible:

- Air: Preselects the media connection "Air".
- Inert gas: Preselects the media connection "Inert Gas".
- Automatic: Automatic media connection preselection depending on the chamber pressure and stoppering status of the product vials:
 - Chamber pressure \geq 950 mbar: Preselection of the media connection "Air".
 - Chamber pressure $<$ 950 mbar: Preselection of the media connection "Inert gas".

Special equipment: Gas injection with a proportional valve (4)

This function can be performed in the manual mode or saved together with a program (see chapter 6.7.3.1 - "Creating a program").

If the freeze-dryer is equipped with a proportional gas injection valve, the dialog box "Gas injection" can be used to preselect the vacuum control method that is to be used.

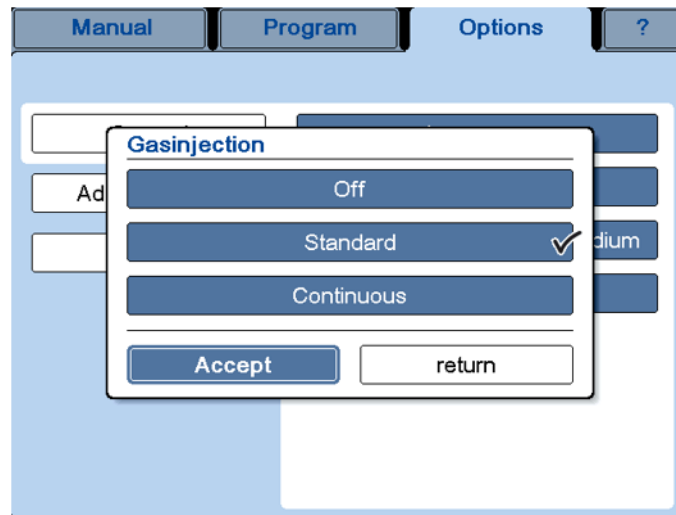

Fig. 40: Dialog box "Gas injection"

The following methods are possible:

- Button "Off": The gas injection is deactivated. Vacuum control is ensured solely by opening and closing the pressure control valve in the suction line of the vacuum pump.
- Button "Standard": Vacuum control is ensured by combined evacuation and gas injection. The gas injection solenoid valve that is installed in series with the proportional valve is continuously open. If the actual vacuum is better than the set value, gas will be injected by opening the proportional valve. The opening width of the valve is automatically controlled. If it is worse than the set value, evacuation will be performed by opening the pressure control valve in the suction line of the vacuum pump.
- Button "Continuous": In the range between 6 mbar and the final vacuum, vacuum control is performed with the pressure control valve and the gas injection solenoid valve being continuously open and solely by varying the injection flow with the aid of the proportional valve. Initially, the proportional valve is closed. Above 6 mbar, the vacuum is controlled using the "Off" method.

Special equipment: Inertisation (5)

(see chapter 6.8 - "Optional extensions and special equipment")

If the "Inertisation" option is active and the freeze-dryer is in the "Standby", "Manual - Freezing", "Program - Loading" or "Program - Freezing" mode, the automatic inertisation of the drying chamber will be performed for the preselected inertisation time after the loading door has been closed. The operating mode then switches to "Run Inertisation".



Fig. 41: Dialog box "Inertisation"

A successful inertisation is a prerequisite for continuing the various processes in the following operating modes:

- Manual
- Program
- Defrosting
- Media drain

An inertisation process can be stopped any time by pressing the "Stop" button.



If the inertisation has been started in the "Manual - Freezing", "Program - Loading" or "Program - Freezing" mode, the "Stop" button will also abort the freeze-drying process!

If the volume flow through the inertisation line falls below a certain threshold for more than 5 seconds (the value can be preset at the flow meter) or if the loading door is opened during an inertisation sequence, the process will also be aborted immediately.



In order to prevent unauthorised access to the "Inertisation" dialog box, we recommend protecting the access to the control system by way of a password (see chapter 6.7.1.3 - "Main window "Options"", section: "Administration"/"Access protection " (4)).

6 Operation

Administration

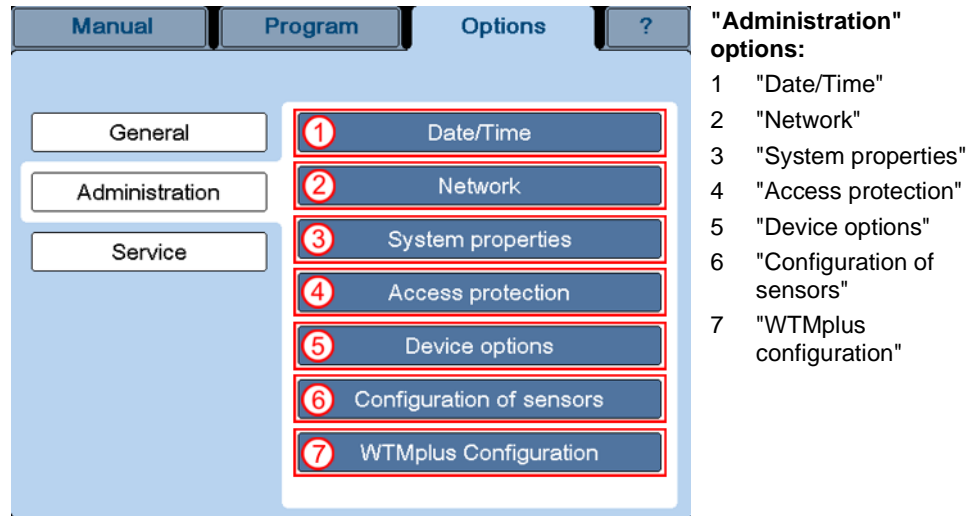

Fig. 42: Dialog box "Options/Administration"

Date/Time (1)

The LSCplus control system is equipped with an integrated, battery-buffered clock. After a failure of the buffer battery, the date and time must be reset.

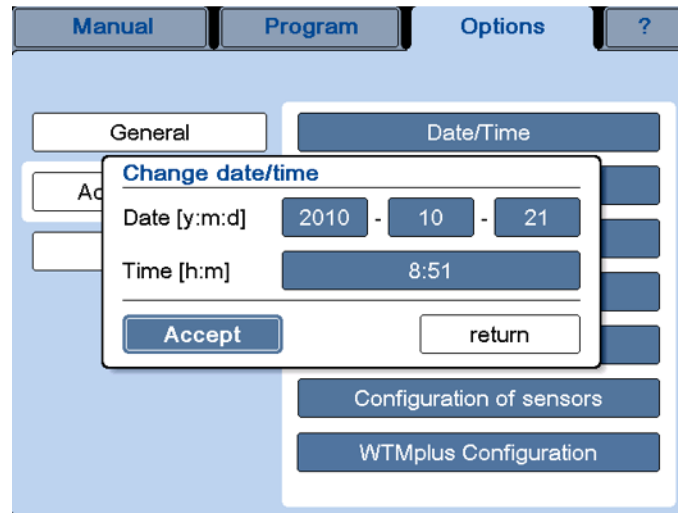



Fig. 43: Dialog box "Change date/time"

Network (2)

This dialog box is used to change various system settings.



NOTE

The modifications will not become effective until after a restart of the unit.

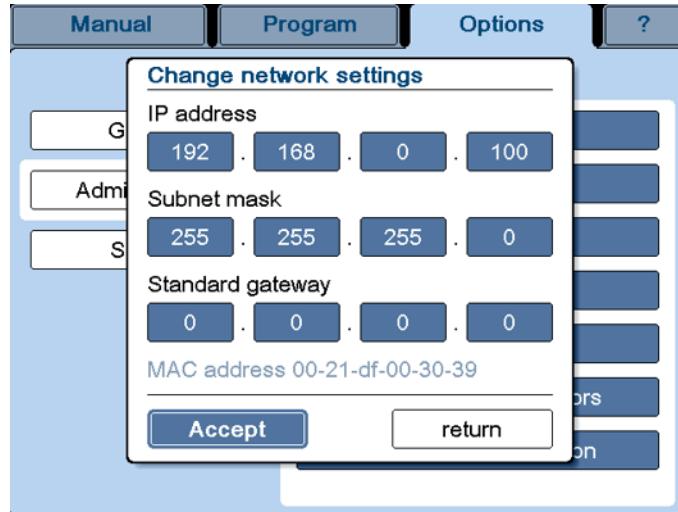

Fig. 44: Dialog box "Network"

System properties (3)

This dialog box is used to change various system settings.

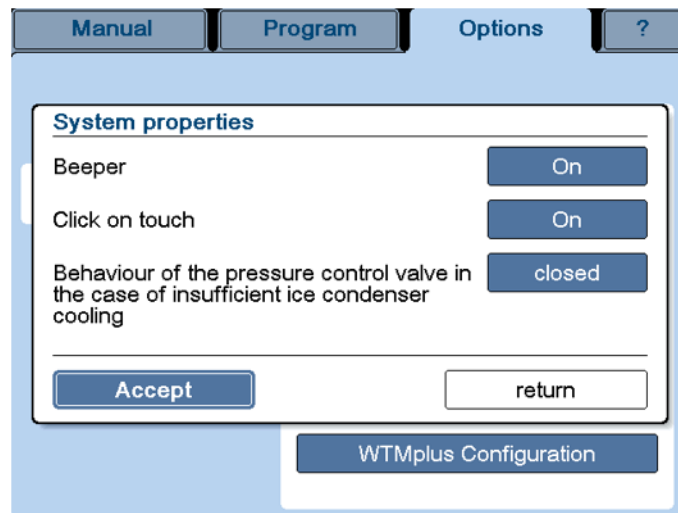

Fig. 45: Dialog box "System properties"

Beeper: The beeper sounds in the event of a malfunction, for example.

- If the setting is "On", the beeper sounds every few seconds until the user acknowledges the message.
- If the setting is "Silent", the beeper sounds once when the malfunction occurs.
- If the setting is "Off", the beeper will not sound at all.

6 Operation

Click on touch: If this function is active, a clicking sound can be heard whenever the system registers that a button has been touched.

Behaviour of the pressure control valve in the case of insufficient ice condenser cooling: If this function is active (button "closed"), the pressure control valve will close at an ice condenser temperature of $\geq -20^{\circ}\text{C}$ during the drying process in order to avoid damage to the vacuum pump caused by the withdrawal of condensable gases. A corresponding error message will be displayed. Pressing the button again deactivates the function (button "controlled").

Access protection (4)

In this dialog box, the access rights can be managed on several levels and they can be protected with a password.

In the factory setting with an activated access protection, data can be viewed but not edited.

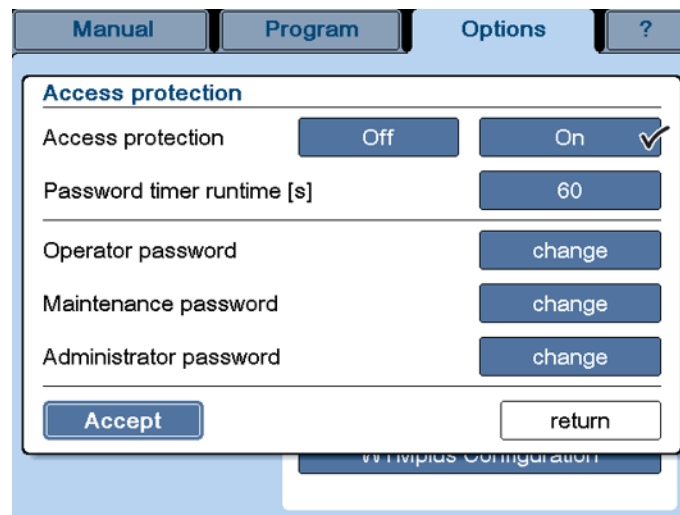

Fig. 46: Dialog box "Access protection"



The other buttons cannot be activated unless the access protection is active.

Password timer runtime: In order to prevent unauthorised access, the system will automatically switch back to the default setting after a pre-defined period of time.

In this case, there is a small lock symbol in the status line and below this symbol the remaining time until the lock will be active is counted down. At the same time a button with a big lock symbol will be displayed in the actual values field.



Fig. 47: Countdown of the password timer and the button with the lock symbol

- The button with the lock symbol blocks the access immediately and the system switches to the default setting.

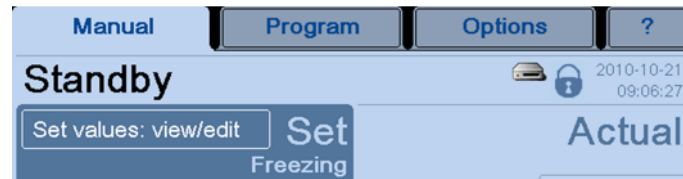

Fig. 48: Access blocked, the data cannot be edited

Operator/maintenance/administrator password: For each of these access levels, certain editing rights have been defined. They can be enabled with the corresponding password.

The rights of the various access levels are detailed in the following table.

Action	Operator	Maintenance	Administrator
Editing of the data of the current process run (e.g. selection of the operating mode, changing of set values)	✓	✓	✓
Editing of maintenance functions (e.g. oil change of the vacuum pump)	--	✓	✓
Editing of the default settings (e.g. editing of the access protection, creating and editing of programs, editing of system settings)	--	--	✓

Device options (5)

This dialog box lists all of the device options that are available for the unit in question. A list of all the possible options can be found at chapter 6.8 - "Optional extensions and special equipment". Options that require a series-number-specific release code are marked with the symbol ("🔒").

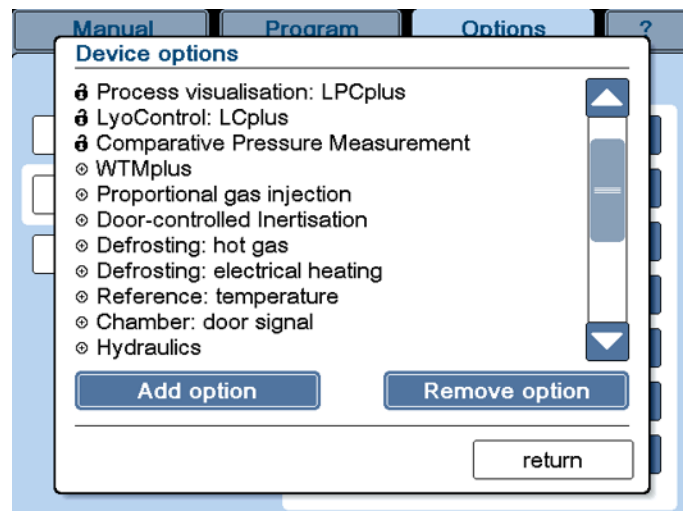

Fig. 49: Dialog box "Device options" (example)

6 Operation

If the freeze-dryer is to be extended by an option, this option must be enabled via this dialog box.

- Press the button "Add option". An input window opens.
- Enter the six-digit Christ activation code that was supplied for this option. Note that the keys are case sensitive.

Options can be removed in the same way.



The modifications will not become effective until after a restart of the unit.

Configuration of sensors (6)



The sensor configurations depend on the equipment version of the unit. If the configuration is incorrect, the correct operation of the unit cannot be guaranteed.

This dialog box is used for the configuration of the existing sensors.

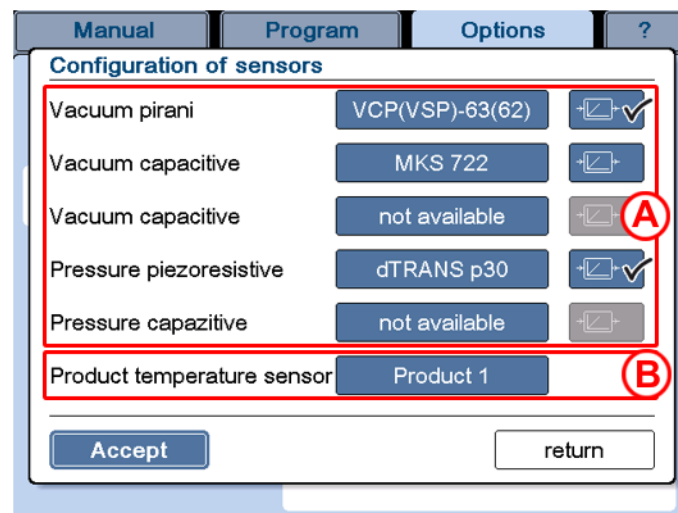

Fig. 50: Dialog box "Configuration of sensors" (example)

Vacuum sensors (see the illustration above, item A)

For the vacuum as well as pressure, there are two different measuring methods, and for each of these methods, different sensors can be selected.

- In order to change the sensor, press the button with the sensor name. The possible models will be displayed one after the other.

The buttons on the right-hand side of the sensors show a control symbol. The tick marks on the buttons indicate the control sensors, i.e. the sensors that are decisive for the vacuum inside the unit. If there is a second sensor, the data of this sensor are simply used for comparison.

*Product temperature sensor (see the illustration above, item B)
Only for systems with a WTMplus system*

The wired product temperature sensor 1 is the default sensor for determining the value " ΔT product" (see chapter 6.7.3 - "Freeze-drying with the PGMplus programmer module", section "Conditions for switching to the next section").

If the freeze-dryer is equipped with a wireless WTMplus temperature measurement system, it is also possible to select a different wired product temperature sensor or a WTMplus sensor:

- Select the button of the product temperature sensor. A drop-down menu showing the available sensors opens.
- Select the sensor that you would like to use for determining " ΔT product".
- Exit the drop-down menu. Select the button "Accept" to close the dialogue box and to save the selection.

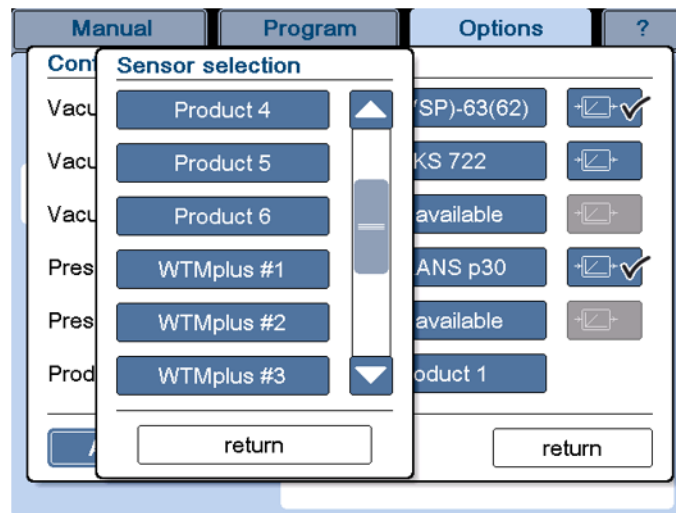

Fig. 51: Selection of the product temperature sensor (only for systems with a WTMplus system)

6 Operation

WTMplus configuration (7)



The dialog box is displayed for information purposes only.
The configuration can be changed only via the LPCplus user interface.

This dialog box shows all of the existing WTMplus sensors. Every sensor is assigned to a measuring channel based on its serial number. Next to the Number of the measuring channel and the serial number of the sensor, the associated temperature and a signal quality index (SQI) are displayed. A bar in the fields indicates the signal quality:

- Green: good signal quality
- Yellow: medium signal quality
- Red: insufficient signal

WTMplus Configuration			
Channel	Number	Temperature [°C]	SQI
#1	0118	20.1	23
#2	0146	20.7	16
#3			
#4	0137	20.2	23
#5	0153	20.5	10
#6	0132	20.8	43
#7			
#8	0165	20.2	27

return

Fig. 52: Dialog box "WTMplus configuration"

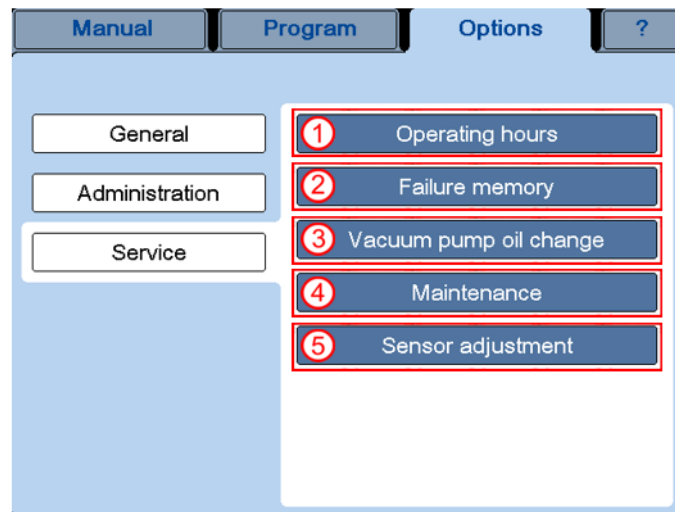
Maintenance

"Service" options:

- 1 "Operating hours"
- 2 "Failure memory"
- 3 "Vacuum pump oil change"
- 4 "Maintenance"
- 5 "Sensor adjustment"

Fig. 53: Dialog box "Service" (varies depending on the type of system)

Operating hours (1)

This dialog box is used to call up the number of operating hours of the various components of the freeze-dryer, e.g. the refrigeration unit, vacuum pump, or pressure control valve. In addition to the name, the → *reference designator* is also displayed.

These data are provided for the purpose of information only. They cannot be edited.

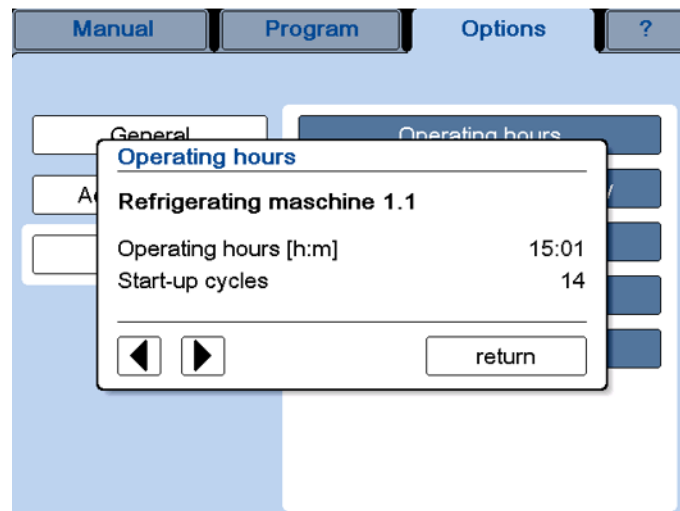

Fig. 54: Dialog box "Operating hours" (here: refrigeration unit 1.1)

Failure memory (2)

Equipment information system. These messages can be viewed in this dialog box. The failure memory includes the last 32 messages. If this number is exceeded, the oldest message will be overwritten.

Use the arrow keys to call up the individual messages.

The error message text is always followed by an error code.

6 Operation



Always indicate the error code in the event of enquiries or service requests!

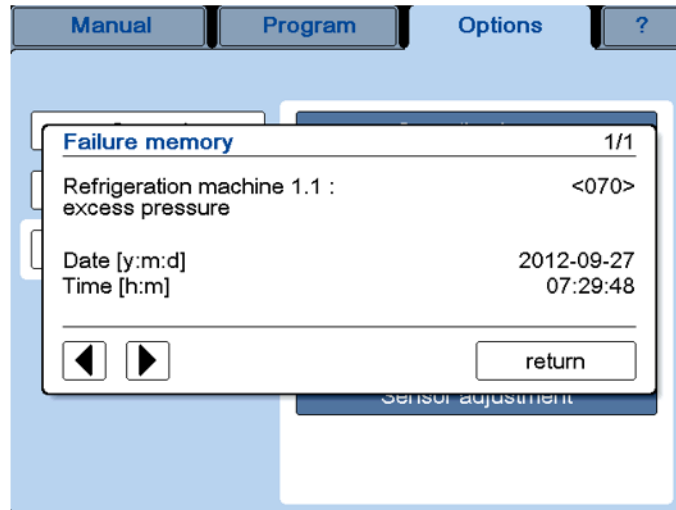

Fig. 55: Dialog box "Failure memory"

Vacuum pump oil change (3)

The system monitors the oil change interval of the vacuum pump. The interval can be adapted to the vacuum pump model and utilisation.

When the end of an oil change interval is reached, a corresponding message will be displayed.

- Acknowledge the message.
- Change the oil of the vacuum pump.
- Reset the operating hour counter in the dialog box "Vacuum pump oil change" by pressing the "reset" button.

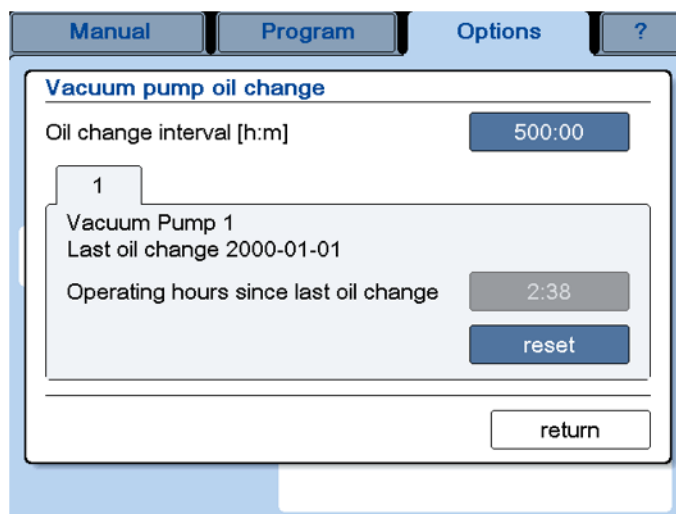

Fig. 56: Dialog box "Vacuum pump oil change"

Maintenance (4)

The maintenance interval of the unit is fixed at 3,000 operating hours or at least one maintenance per year.

When the end of a maintenance interval is reached, a corresponding message will be displayed.

- Acknowledge the message.
- Make an appointment for the maintenance of your freeze-dryer.
- After the maintenance, our service engineer will reset the operating hour counter in the dialog box "Maintenance".

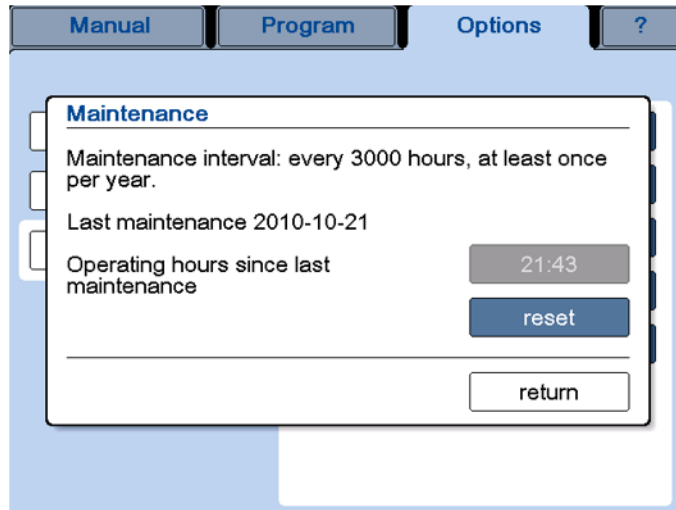



Fig. 57: Dialog box "Maintenance"

Sensor adjustment (5)

In this dialog box, the sensors are adjusted in terms of a predefined reference value.



Misadjusted sensors will lead to incorrect measurement values, which in turn will have a negative effect on the process control.

CAUTION



The sensor adjustment must be carried out by authorised specialist personnel.

NOTE

6 Operation

6.7.1.4 Main window "?"

This main window includes the most important information concerning your freeze-dryer:



Fig. 58: Freeze-dryer system information



In the event of enquiries at the manufacturer, please state the number that is stated here.

6.7.2 Manual freeze-drying

In the manual mode, the user switches manually from one freeze-drying phase to the next. The manual mode is activated by calling up the main window "Manual".

The set values for the individual process phases (freezing, warm-up, main drying, and final drying) are defined prior to the start of the process. Then, the freeze-drying process can be started via the dialog box "Operating mode: select/start".



If the freeze-drying process is to be started directly with the "main drying" (sublimation) phase, the vacuum pump must be warmed up approximately 15 minutes prior to the process start. Failure to do so will result in a corresponding warning message when the process starts.



If "∞" (infinite) has been preselected for a phase, the next phase must be selected manually by way of the button "Operating mode: select/start".

In the manual mode, the set values of the active phase can be changed during the process run. In this case, the control system adapts the unit to the new set values as quickly as possible.

After the completion of a phase, the system switches to the next phase without switching the unit to standby. The transition from "freezing" to "warm-up" takes place automatically. After the completion of the warm-up phase, this dialog box will be displayed:

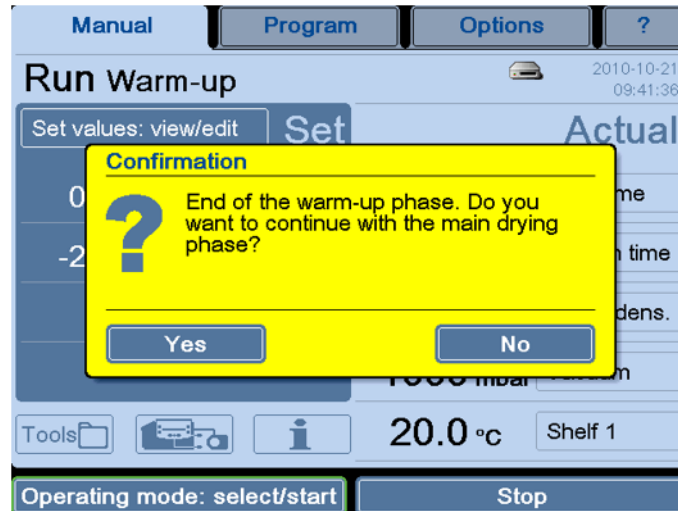

Fig. 59: Dialog box after the completion of the warm-up phase

The unit will remain in the warm-up phase until you confirm.

The transition from "main drying" to "final drying" again takes place automatically. After the completion of the "final drying" phase, the system displays another enquiry with which the freeze-drying process will be terminated. The unit remains in the "run" mode until the enquiry is confirmed.

The process can be stopped any time by pressing the "Stop" button. In this case, the unit will be switched to standby.

6.7.2.1 Entering set values in the manual mode

The system has stored set values for every phase, and for every value there are pre-defined value ranges that can be determined in the various dialog boxes by pressing the buttons "min" and "max".

In order to protect the product, a \rightarrow *safety pressure* value can be entered in every drying section.

6 Operation

Viewing or editing the set values:

- Press the button "Set values: view/edit" (see chapter 6.7.1.1 - "Main window "Manual""). The following dialog box will be displayed:

	Freezing	Warm-up	Main drying	Final drying
Section time h:m	∞	0:20	∞	∞
Shelf °C	-20.0	-20.0	20.0	30.0
Vacuum mbar			1.00	.0010
Safety press. mbar			off	off

1 Aeration	2 Defrosting	3 Media drain
4 Leakage test		

Accept	return
--------	--------

1 "Aeration" button
 2 "Defrosting" button
 3 "Media drain" button (special equipment)
 4 "Leakage test" button

Fig. 60: Dialog box "Set values: view/edit"

Fields that are displayed in the form of buttons can be edited.

- Aeration (1)**
If the freeze-dryer is equipped with an automatic aeration valve, this button is used to define the aeration pressure.
- Defrosting (2)**
This button is used to pre-define the defrosting time and temperature (not for hot-water defrosting). In addition, this button is used to define whether the operating mode "media drain" (see below) will be started automatically after the defrosting process.
- Media drain (3)**
If the freeze-dryer is equipped with an automatic media drain for condensate water or another medium, the opening time of the drain valve can be pre-selected in this dialog box.
- **Leakage test (4)**
This button displays the parameters that are used for the leakage test. In addition, the test time and the chamber volume must be stated (depending on the accessories that are used).

Numerical values can be edited with the aid of a numerical keypad:

6 Operation

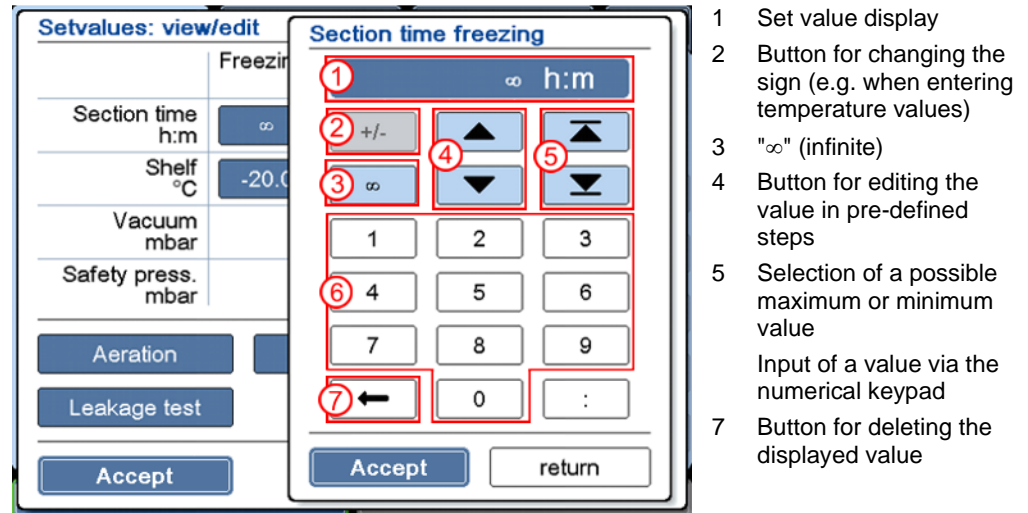

- 1 Set value display
- 2 Button for changing the sign (e.g. when entering temperature values)
- 3 "∞" (infinite)
- 4 Button for editing the value in pre-defined steps
- 5 Selection of a possible maximum or minimum value
- 6 Input of a value via the numerical keypad
- 7 Button for deleting the displayed value

Fig. 61: Editing set values

- Confirm the new value and quit the numerical keypad by pressing the button "Accept".
- Confirm the input and quit the dialog box via the button "Accept".
- If the dialog box is closed by the button "return", the changes will be discarded.

6.7.3 Freeze-drying with the PGMplus programmer module

Unlike in the manual mode, an entire freeze-drying process can be executed fully automatically and under reproducible conditions with the aid of the PGMplus programmer module.

Freeze-drying programs are divided into sections (1). Every section in the program has certain set values (2). A program must include a minimum of two sections, and the maximum number of possible sections is 64. 32 program storage locations are available.

In every program, the system always displays four consecutive sections in order to show their connection.

Manual		Program		Options		?	
01. Christ standard		Duration		Sections		22:00 14	
(1) ◀ Load		Freezing ▶					
Sec.01		Sec.02		Sec.03		Sec.04	
(2) Time h:m		1:00		1:00		0:30	
Shelf °C		20.0		-20.0		-15.0	
Vacuum mbar						>> more	
Safety press. mbar						Copy program	
ΔT shelf °C		off		off		off	
ΔT product °C		off		off		off	
LyoControl-Fx %		off		off		off	
						Delete program	
						Save	

Fig. 62: Representation of a freeze-drying program

6 Operation

Program sections

When the programmer module executes a freeze-drying process, it executes the various sections that were created one after the other until the last section is completed.

Within the various sections, the system calculates linear ramps for the temperature and vacuum. These ramps start with the set value of the previous section and end with the set value of the current section.

As a result, there is not abrupt change of the set value from section to section, but a steady adaptation.

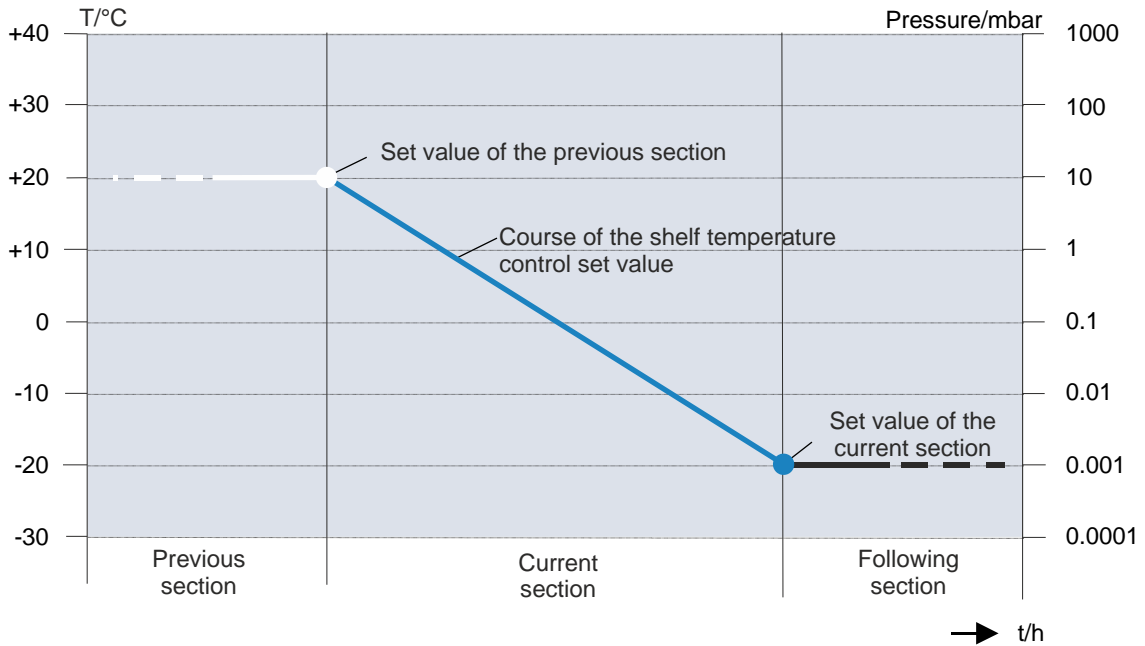

Fig. 63: Graphical representation of the course of the control set value

In order to protect the product, a → *safety pressure* value can be entered in every drying section.

Conditions for switching to the next section

For all of the program sections to be executed automatically, certain switching conditions must be fulfilled at the end of each section. If these conditions are not fulfilled, e.g. due to incorrect set values, a corresponding process message will be displayed and the section will be extended.

Ice condenser temperature: This value is checked only when the system switches from freezing (loading) to drying. The ice condenser temperature must be $\leq -40^{\circ}\text{C}$.

Vacuum: This value is checked only during the drying phase. The actual vacuum can differ from the set value by 20% maximum. In the case of a set value of 0.001 mbar (final vacuum), there will be no check. In order to reach the vacuum as quickly as possible, a section time of 1 minute can be preselected. Since this is not possible in practice, a process message will be issued for the first time after 15 minutes in this case.

ΔT shelf: This value defines the permissible deviation of the shelf temperature from the set value. At the end of the section, the actual temperature of the shelves (in the case of WST shelf 1) will be compared to the set value. If the shelf temperature is beyond the permissible range, the section will be extended until the deviation is within the permissible range.

ΔT product: This value defines the permissible deviation of the product temperature from the set value. By default, the wired product temperature sensor 1 is used. If the freeze-dryer is equipped with the wireless WTMplus temperature measurement system, it is also possible to select a different wired product temperature sensor or a WTMplus sensor (see chapter 6.7.1.3 - "Main window "Options", section "Administration"/"Sensor configuration").

During the freezing phase, the product temperature may exceed the set value by the defined value. In the drying phase, the system will provide a signal to the user if the actual value lies below the set value by more than the permissible deviation.

LyoControl-Rx (option with LyoControl LCplus): The value LyoRx defines the minimum permissible value of the LyoControl sensor (measured by the LyoControl sensor 1) during the drying phase. If the actual value falls below this limit, the shelf heater will be switched off in order to prevent the product from thawing due to excessive energy input by the shelf temperature control system. The LyoControl value is checked only during the main and final drying phases.

Δp pressure increase test (option): Depending on the selected mode, the pressure increase test can also be used as a condition for switching to the next section (see chapter 6.7.3.1 - "Creating a program", option: pressure increase test). In the last drying section, two pressure increase tests will be performed and evaluated. If both values are not greater than the specified "pressure increase" parameter, the condition for switching to the next section is fulfilled. If this is not the case, the section will be extended. If the actual value exceeds the set value before the preselected time has elapsed, the test will be aborted in order to prevent the product from thawing.

ΔT comparative (option): This value indicates the difference between a Pirani sensor and a capacitive vacuum sensor in per cent based on the actual value of the capacitive vacuum sensor. When the sublimation rate decreases, the difference decreases as well. As a result, the value is an indicator for determining the drying end of the main draining phase. If the set value is not reached by the end of the main drying phase, the section will be extended.

6 Operation



If only capacitive sensors are permissible (e.g. for freeze-drying solvent-containing products), comparative pressure measurement is not possible.

Vacuum pump warm-up

Apart from the execution of the various sections, the PGMplus programmer module also controls other tasks that need to be performed during the process run, e.g. the automatic activation of the vacuum pump.

If the pressure control valve is closed, the PGMplus programmer module shifts the warm-up phase of the vacuum pump to the freezing phase so that it is **before** the first drying section. Since the pressure control valve remains closed during the warm-up of the vacuum pump, neither the freezing phase nor the pressure inside the drying chamber will be affected.

The duration of the warm-up phase can be specified separately for every program (see chapter 6.7.3.1 - "Creating a program").

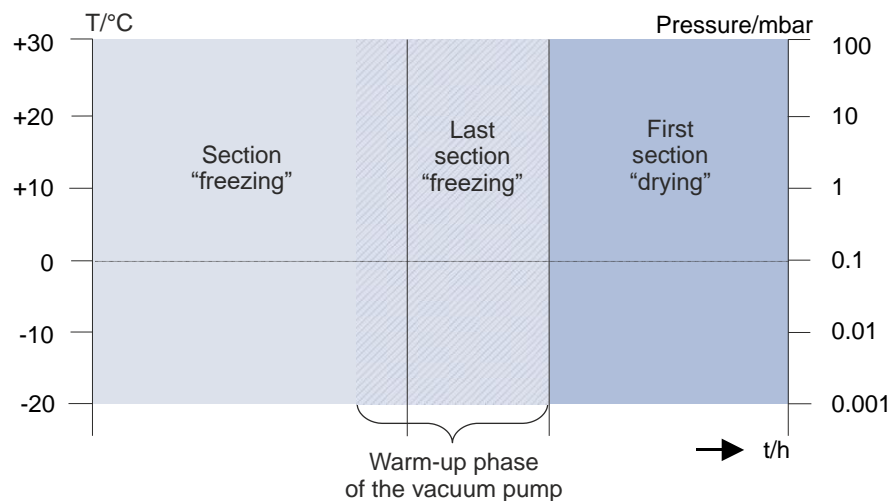

Fig. 64: The warm-up phase of the vacuum pump is shifted to the freezing phase prior to the first drying section

6.7.3.1 Creating a program

To create a new program:

- Press the button "New program" in the main window "Program". The dialog box that is displayed offers various different program templates. The scroll bar on the right-hand side can be used to scroll through the list.

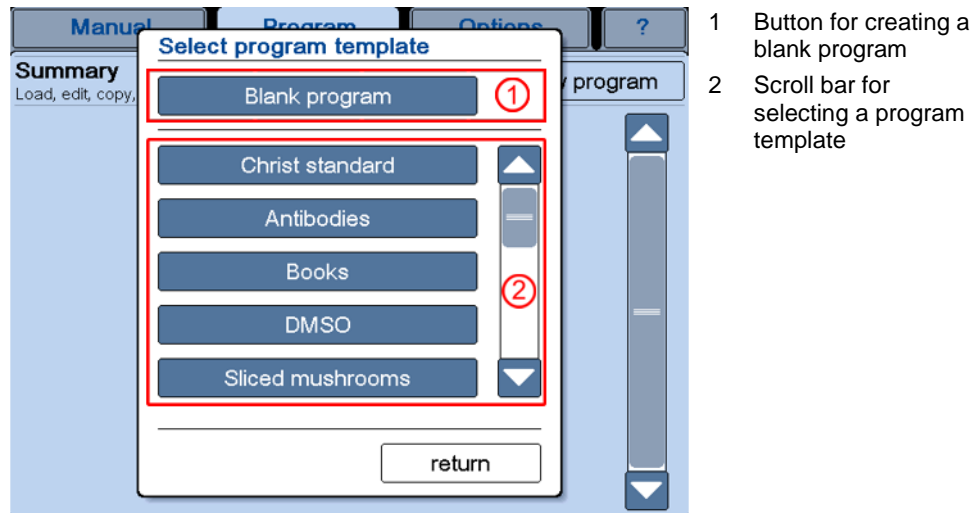

Fig. 65: Dialog box "Select program template"

Creating a blank program (1)

This button is used to call up a blank program template. Only section 1 is pre-defined as the loading section. In this phase, the start conditions of the programs are defined. The room temperature (20°C) is the standard default.



If the product is frozen outside the freeze-dryer (→ *double-chamber method*), the shelf temperature must be adapted accordingly in section 1.

For all the other sections, the set values must be defined (see figure below):

- Press the button "Insert section" (4) and select the position of the section as well as the freeze-drying phase. The section will be inserted at the defined position.
- Adapt the parameters of the inserted section. All of the values are not available in all of the freeze-drying phases.
- Insert and edit the next section.



During the creation of a program, the order of the individual freeze-drying phases must be maintained. This means that it is not possible to insert a freezing section after a main drying section.

6 Operation

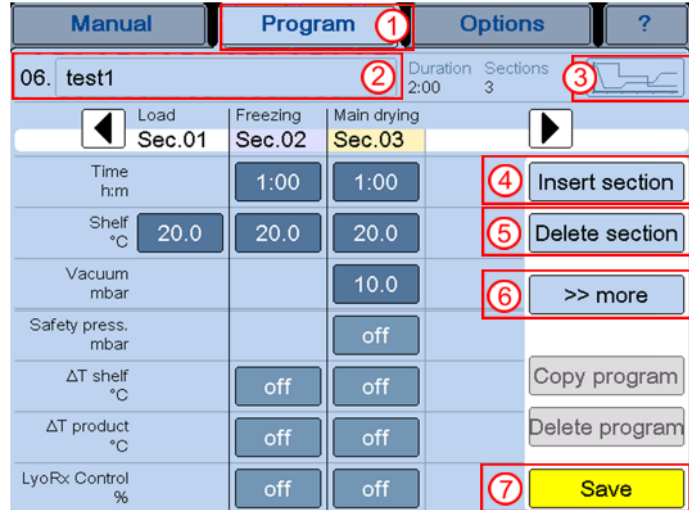

"Program" buttons:

- 1 "Program"
- 2 "Program name"
- 3 "Show diagram"
- 4 "Insert section"
- 5 "Delete section"
- 6 Button for calling up more functions and set values
- 7 "Save"

	Load Sec.01	Freezing Sec.02	Main drying Sec.03	
06. test1				Duration 2:00 Sections 3
Time h:m		1:00	1:00	4 Insert section
Shelf °C	20.0	20.0	20.0	5 Delete section
Vacuum mbar			10.0	6 >> more
Safety press. mbar			off	
ΔT shelf °C		off	off	Copy program
ΔT product °C		off	off	Delete program
LyoRx Control %		off	off	7 Save

Fig. 66: Editing a blank program template

- The button "Delete section" (5) can be used to delete sections.
- The button ">>more" (6) can be used to enter more functions and set values in a program-related manner, depending on the type of freeze-dryer (see the sections below).
- Proceed in this manner in order to create an entire program according to your specific needs.
- Pressing the button "Diagram" (3) displays the program in the form of a diagram.
- Pressing the button "Program name" (2) calls up an input field in which the name of the program can be changed.
- The button "Save" (7) can be used in between or at the end of the program creation in order to save the program.
- The button "Program" (1) calls up the main window. The system will ask the user whether the program shall be saved if this has not been done yet.

The program will be automatically assigned to the first free program storage location. The creation of the program is now complete and it can be loaded.

Button ">>more"

The button ">>more" can be used to enter more functions and set values in a program-related manner.

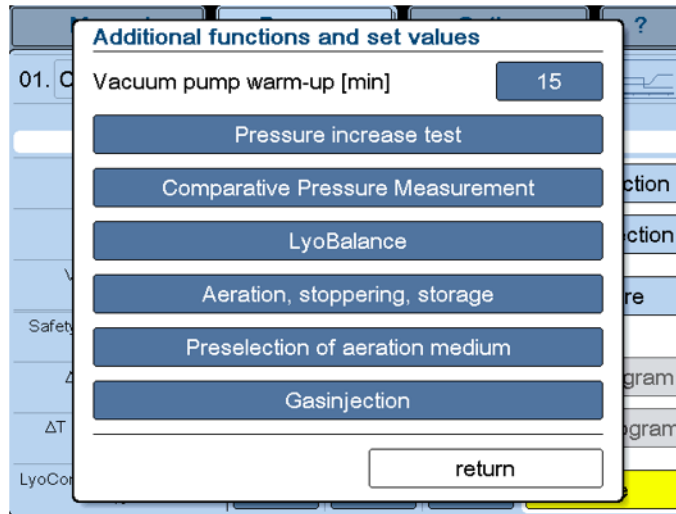

Fig. 67: Selection of program-related functions and set values

Vacuum pump warm-up

see chapter 6.7.3 - "Freeze-drying with the PGMplus programmer module"

Option: Pressure increase test (only with the → double-chamber method)

The → pressure increase test can only be performed when the freeze-dryer is equipped with an intermediate valve.



The indication of the measurement value "dp Test" can be configured in chapter 6.7.1.1 - "Main window "Manual"" under "Actual values of the current process" in the dialog box "Select actual value".

In contrast to the pressure increase test in the manual mode, repeated pressing of the button in the program mode enables the selection of different variants.

- Periodic pressure increase test:
The test will be performed periodically during the entire main or final drying phase. The parameters "Duration test" and "Time between tests" apply. The maximum pressure increase is limited to 100%, referring to the actual value at the beginning of the measurement. If the value is exceeded, the pressure increase test will be aborted in order to prevent the product from thawing.
- Progress condition:
In the last main drying or final drying section, two pressure increase tests will be performed and evaluated. The start point will be calculated automatically by the control system. The parameters "Duration test" and "Time between tests" apply.
If, during both tests, the values of the pressure increase test are not greater than the preset "Pressure increase" parameter, the drying process will be considered complete at the current shelf temperature and chamber vacuum. Thus, the progress condition for switching to the

6 Operation

next section is fulfilled and the next section will be initiated.

If the condition for switching to the next section is not fulfilled, a process message will be issued, the current section will be extended, and further pressure increase tests will be executed periodically until the condition is fulfilled. If the actual value exceeds the set value before the preselected time has elapsed, the test will be aborted in order to prevent the product from thawing.

- Periodic & progress condition:

This variant is a combination of the possibilities that are described above. The test will be performed periodically during the entire main or final drying phase. The maximum pressure increase is limited to 100%, referring to the actual value at the beginning of the measurement. If the actual value exceeds the set value before the preselected time has elapsed, the test will be aborted in order to prevent the product from thawing.

If, during both tests, the values of the pressure increase test are not greater than the preset "Pressure increase" parameter, the drying process will be considered complete at the current shelf temperature and chamber vacuum. Thus, the progress condition for switching to the next section is fulfilled and the next section will be initiated.

If the condition for switching to the next section is not fulfilled, a process message will be issued, the current section will be extended, and further pressure increase tests will be executed periodically until the condition is fulfilled.

- Disabled:

No pressure increase test will be executed during the main or final drying phase. There will be no evaluation.

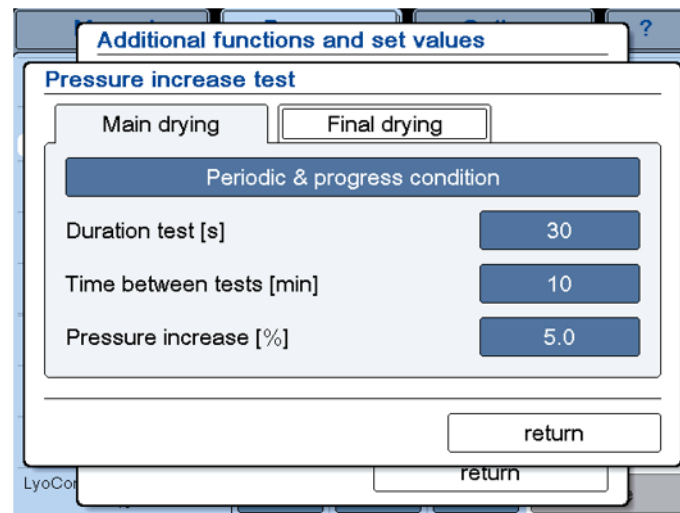

Fig. 68: Dialog box "Pressure increase test" in the program mode

*Option: → Comparative pressure measurement
(see chapter 6.8 - "Optional extensions and special equipment")*



The indication of the measurement value "dp Comp" can be configured in chapter 6.7.1.1 - "Main window "Manual"" under "Actual values of the current process" in the dialog box "Select actual value".



If only capacitive sensors are permissible (e.g. for freeze-drying solvent-containing products), comparative pressure measurement is not possible.

The comparative pressure measurement can be activated or deactivated by pressing the button in the dialog box.

- Progress condition:**
 If the difference between the readings of the Pirani and the capacitive vacuum sensor at the end of the last main drying section is below the limit " Δp Comparative", the drying process will be considered complete at the current shelf temperature and chamber vacuum. Thus, the progress condition for switching to the next section is fulfilled and the next section will be initiated.
 If the condition for switching to the next section is not fulfilled, a process message will be issued, the current section will be extended, and further pressure increase tests will be executed periodically until the condition is fulfilled.
- Disabled:**
 There will be no comparative pressure measurement during the main drying phase. There will be no evaluation.

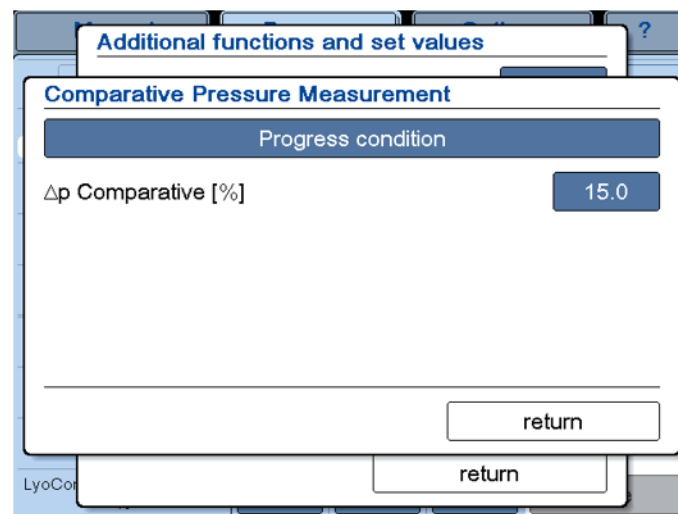

Fig. 69: Dialog box "Comparative pressure measurement"

6 Operation

Option: LyoBalance weighing system

If the freeze-dryer is equipped with a LyoBalance weighing system (see chapter 6.8 - "Optional extensions and special equipment"), then the corresponding parameters must be configured in this dialog box.



Please refer to the separate operating manual of the weighing system!

Option: → Aeration, stoppering, storage

(see chapter 6.8 - "Optional extensions and special equipment")

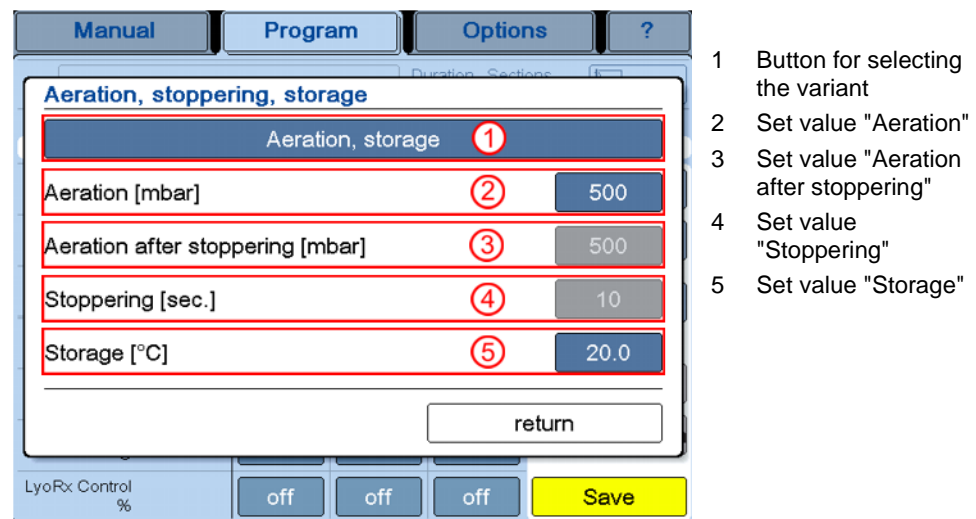

Fig. 70: Dialog box "Aeration, stoppering, storage"

Repeated pressing of this button enables the user to choose between the following variants:

- Deactivated
- Aeration (up to the "Aeration" value) and subsequent storage
- Stoppering (at drying vacuum followed by aeration up to atmospheric pressure) with subsequent storage
- Aeration (up to the "Aeration" value), stoppering (followed by aeration up to atmospheric pressure) with subsequent storage

The set values of the parameters can be adapted by way of the respective button if the button is shown with a blue background.



A set value for the aeration ≤ 10 mbar can only be reached if the freeze-dryer is equipped with a precision needle valve for the gas injection.

"Aeration, (stoppering), storage" procedure:

1. Aeration up to the desired partial vacuum ("Aeration" value):
After the actual freeze-drying process has been completed, the ice condenser continues to be cooled and the shelves are held at the temperature of the last drying section. The system is aerated until the desired partial vacuum is reached ("Aeration" value, see the illustration above, item 2).



The product vials must be sealed at a chamber pressure below 900 mbar in order to prevent the stoppers from being pushed out of the vials at low atmospheric pressure.



If the set value for the aeration is below the current chamber pressure, the aeration phase will be skipped. The current chamber pressure will be maintained.

2. Stoppering followed by aeration up to atmospheric pressure
While the ice condenser continues to be cooled and the shelf temperature is maintained, the shelves are moved together in order press the Lyo stoppers into the product vials. The stoppering pressure is maintained over the specific "Stoppering" time (see the illustration above, item 4). The subsequent final aeration is performed in two steps. In the first step, the system is aerated up to the partial vacuum that is stated under "Aeration after stoppering" (see the illustration above, item 3). Then, the shelves are moved apart into the drying position. In the second step, the system is aerated up to atmospheric pressure. This method prevents the stoppers from being ejected from the vials (if the shelves are moved apart without any prior aeration) and also from sticking to the shelves (if the shelves are not moved apart until the aeration to atmospheric pressure is complete).
3. Storage under defined conditions
The shelves are brought to the set "Storage" temperature (see the illustration above, item 5) in order to store the product under optimum conditions. These conditions are kept constant until the system is manually set to the standby mode for unloading.



If the variant "Aeration, storage" has been selected, the product is stored at the "Aeration" pressure. In this case, the system must be aerated manually up to atmospheric pressure prior to opening the loading door.

Parameter	No.	Value range	Default setting
Aeration	2	0.001 mbar...900 mbar	500 mbar
Aeration after stoppering	3	0.001 mbar...900 mbar	500 mbar
Stoppering	4	1 sec....999 sec	10
Storage	5	-99.9°C...60.0°C	20°C

6 Operation

Special equipment: Preselection of the aeration medium

If the freeze-dryer is equipped with an automatic aeration valve and automatic valves for media selection, this dialog box can be used to preselect the medium that is to be used for the aeration medium requests during the execution of the particular program.

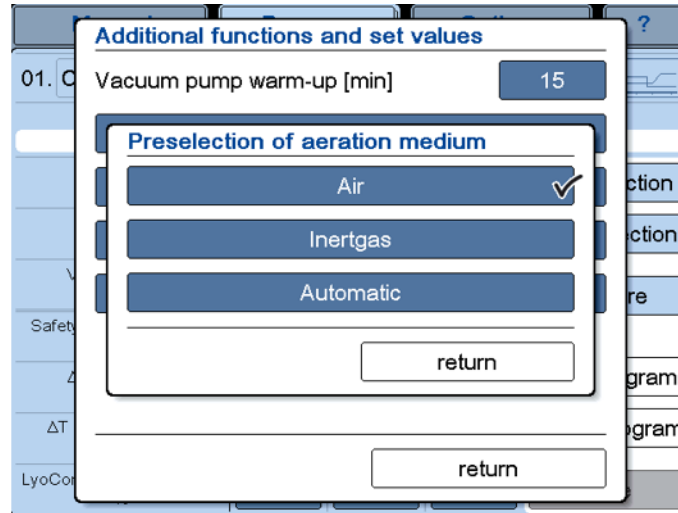

Fig. 71: Dialog box "Preselection of aeration medium"

If the vacuum control system of the freeze-dryer uses a regulated gas admission (injection), the preselected medium will be used for this purpose. If the freeze-dryer is equipped with the "Aeration, Stoppering, Storage" option, the preselected medium will be used for the aeration up to stoppering (backfilling) as well as for the final aeration up to atmospheric pressure.

The following media preselection settings are possible:

- Air: Preselects the media connection "Air".
- Inert gas: Preselects the media connection "Inert Gas".
- Automatic: Automatic media connection preselection depending on the chamber pressure and stoppering status of the product vials:
 - Chamber pressure ≥ 950 mbar or product vials already sealed by way of "Aeration, Stoppering, Storage": Preselection of the media connection "Air".
 - Chamber pressure < 950 mbar and product vials not yet sealed by way of "Aeration, Stoppering, Storage": Preselection of the media connection "Inert gas".

As a result, during automatic aeration, stoppering, and storage, backfilling can be performed automatically with inert gas and the subsequent aeration of the chamber up to atmospheric pressure with air.

Special equipment: Gas injection with a proportional valve (4)

See chapter 6.7.1.3 - "Main window "Options"", section "Special equipment: Gas injection with a proportional valve"

Program templates (2)

The PGMplus programmer module offers various program templates that include recipes for all kinds of freeze-drying applications. They are suggestions for orientation purposes and must be adapted to the specific area of application of the freeze-dryer.



Some of the tests that are described under chapter 6.7.1.1 - "Main window "Manual"", section "Operating mode: select/start", are also available in the form of program templates.

Following the selection of a program template, a window containing information concerning the drying process will be displayed.

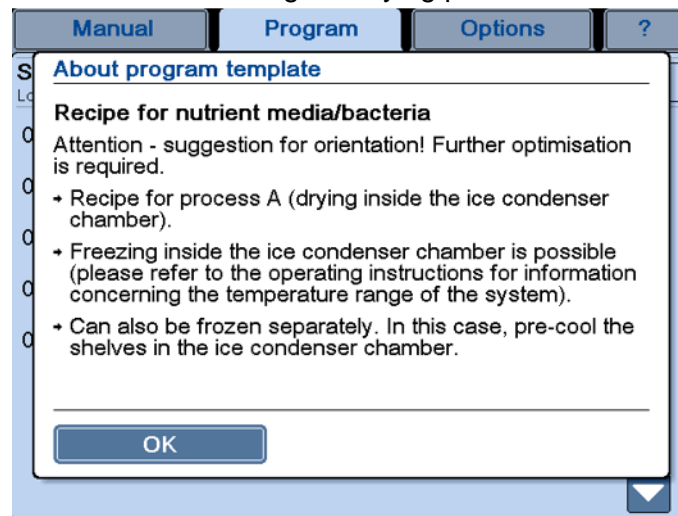

Fig. 72: Information concerning the program template (here: a recipe for nutrient media/bacteria)

After the conformation of the information, the program template will be displayed.

- Similar to a blank program, sections can be added or deleted and the set values can be adapted accordingly.

6.7.3.2 Editing a program

An existing program can be modified as long as it has not been loaded.

- Select the program to be edited from the list in the main window "Program".
- Press the button with the program name in order to call up a window that displays the program data.
- Perform the desired modifications and save the program (see chapter 6.7.3.1 - "Creating a program").
- Close the dialog box by pressing the "Program" button.

The program has now been changed in the existing program storage location.



It is possible to switch to the manual mode during a program run, e.g. in order to edit a program during the runtime. The point of time for continuing the program run can be defined by selecting the desired start section and a start time.

6 Operation

6.7.3.3 Copying a program

If a new program is to be created based on an already existing program, the already existing program can be copied. A free program storage location must be available for this purpose.

- Select the program to be copied from the list in the main window "Program".
- Press the button with the program name in order to call up a window with the program data.
- Press the button "Copy program" in order to create a copy of the existing program.
- Edit and save the copy (see chapter 6.7.3.1 - "Creating a program").
- Close the dialog box by pressing the "Program" button.

The program will be automatically assigned to the first free program storage location.

6.7.3.4 Loading a program

If a freeze-drying process is to be executed and controlled by a program, the program must be loaded.

- Call up the main window "Program". This window includes a list of all the programs that are saved.
- Press the button "Load" behind the program name. A dialog box will be displayed in which the start section, the start time or the start temperature can be adapted to any specific needs. The "Info" button can be used to call up a brief description of the active program, including information concerning the remaining runtime and the end of the program. It also enables a graphical representation of the process sequence.

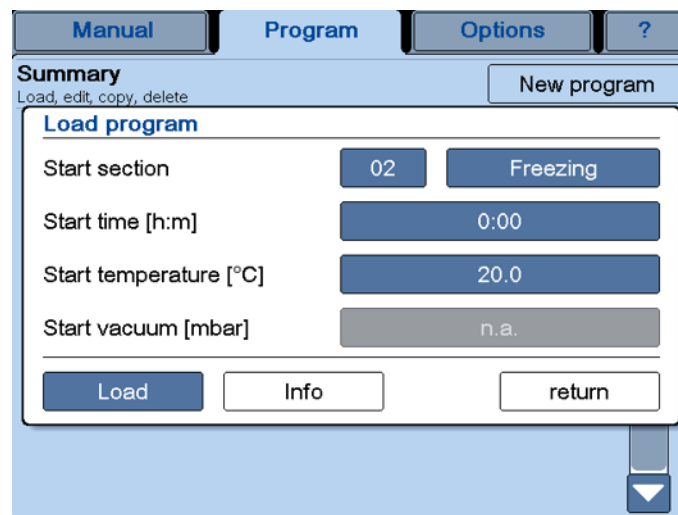

Fig. 73: Dialog box "Load program"

- Press the button "Load" in order to accept the program data. The display switches to the standard user interface.
- Press the button "Program start" in order to start the freeze-drying process.



Fig. 74: The freeze-drying process can be started with the aid of the button "Program start".

- During the freeze-drying process, the description of the active program can also be called up from the main window "Program" and via the button "Info".
- When the "Stop" button is pressed, the freeze-dryer switches to the standby – manual freezing mode.



The program starts with section 02 "Freezing" by default. If, however, section 01 "Load" is to be used as the starting point of the program, this section must be selected manually. In this case, the button "Program continue" will be displayed after the start of the program. When the precooling (loading) process is complete, this button must be pressed in order to continue with the program.

6.7.3.5 Deleting a program

The PGMplus programmer module offers 32 program storage locations. If they are all occupied, a program must be deleted before a new one can be created.

- Select the program to be deleted from the list in the main window "Program".
- Press the button with the program name in order to call up a window with the program data.
- Press the button "Delete program". The system will then display a dialog box with an enquiry.
- Following the confirmation of the enquiry, the program will be deleted.

The program storage location on the list is now empty and the number is not shown on the list.

6 Operation

6.8 Optional extensions and special equipment

Aeration, stoppering, storage

see also chapter 6.7.3.1 - "Creating a program", Button ">>more"

This option is available only in combination with the PGMplus programmer module and if the freeze-dryer is equipped with an automatic aeration valve and a hydraulic shelf movement system. It offers automatic sealing of the product vials with pre-inserted rubber stoppers under partial vacuum and subsequent storage on the shelves under defined conditions as an integral part of a freeze-drying program.

Pressure increase test

see also chapter 6.7.3.1 - "Creating a program", Button ">>more"

The pressure increase test can only be performed with the → *double-chamber method*. During the pressure increase test, the intermediate valve prevents the flow of steam from the drying chamber to the ice condenser so that the water vapour of the → *sublimation* cannot flow off. The result is a more or less distinct pressure increase that is measured in the product chamber. The pressure increase test is used as a criterion for the automatic switching from the main drying phase to the final drying phase as well as for identifying the end of the process.

Gas injection with a proportional valve

see also chapter 6.7.1.3 - " Main window "Options"", section "General"

If the freeze-dryer is equipped with a proportional gas injection valve, the method that is to be used for vacuum control can be preselected. The method can be saved together with a recipe.

Improved cooling rate (fast freezing)

Refrigeration unit 1 is used for cooling the ice condenser. Refrigeration unit 2 cools the heat transfer fluid that is used for controlling the temperature of the shelves. If the device option "Improved cooling rate" is activated (see chapter 6.7.1.3 - " Main window "Options""/Administration/Device options), the ice condenser refrigeration unit will be used during the "Freezing" phase to support the cooling of the heat transfer fluid. This enables higher freezing rates.

This option is only available for freeze-dryers of the Epsilon 2-6D LSCplus and Epsilon 2-10D LSCplus type.

Inertisation

see also chapter 6.7.1.3 - " Main window "Options"", section "General"

If products containing solvent are dried in an oxygen atmosphere, explosive mixtures may form. In order to dry these types of products, the freeze-dryer must be equipped with a door-controlled inertisation system that uses nitrogen or another inert gas.

Comparative pressure measurement

see also chapter 6.7.3.1 - "Creating a program", Button ">>more"

During the → *sublimation*, i.e. when the concentration of water vapour molecules is rather high in the atmosphere, the value that is provided by the gas-type-dependent vacuum sensor of the "Pirani" type (e.g. Thyracont VCP 63) in the drying chamber deviates from the value that is provided by a capacitive vacuum sensor (e.g. MKS 722B). When the proportion of water vapour molecules decreases towards the end of the main drying phase, the two sensors fall increasingly in line with one another. This difference will be evaluated and used as an indicator for identifying the drying end of the main drying phase.

USB process recording

see also chapter 6.7.2 - "Manual freeze-drying", section "Dialog box "Tools""

This feature enables the recording of a running process on a USB storage medium. After the end of the process recording, the process data can be viewed on the PC with LyoLogplus and they can be printed. It is also possible to import the data directly into an Excel file.

Preselection of the aeration medium

see also chapter 6.7.1.3 - "Main window "Options"", section "General"

If the freeze-dryer is equipped with an automatic aeration valve and automatic valves for media selection, a special medium can be preselected that is to be used for all of the aeration medium requests as of the start of the main drying phase.

LyoBalance weighing system

see also chapter 6.7.1.1 - "Main window "Manual"", dialog box "Tools"

The LyoBalance weighing system enables the user to determine the weight loss of a product during a freeze-drying process. The drying rate that results from the weight loss provides information concerning the progress of the freeze-drying process. Thereby, it also helps the user to determine the end of the freeze-drying process and to optimise the process parameters.

Wireless product temperature measurement system WTMplus

The wireless product temperature measurement system WTMplus has been developed mainly for freeze-dryers in the production area. The sensors are positioned directly in the product. They transfer their measurement values to an antenna that is integrated in the drying chamber. This enables the continuous monitoring of all of the phases of the freeze-drying process.

LyoCam monitoring camera system

The LyoCam monitoring camera system is used to monitor and analyse freeze-drying processes. A high-quality camera takes pictures of the product at intervals from several seconds to several minutes. The intervals are variable depending on the process section. The pictures are linked to the LPCplus SCADA system for process visualisation and they are assigned a time stamp in line with other recorded process parameters.

6 Operation

Controlled Nucleation LyoCoN

The LyoCoN process enables the simultaneous freezing of all vials inside the drying chamber. To this end, ice crystals are accumulated on the cold ice condenser. At the same time, the liquid product is cooled to a temperature close to the freezing point. Then, a slight vacuum is generated inside the freeze-dryer. A reservoir, which has been installed externally, remains at atmospheric pressure. When the valve between the external reservoir and the ice condenser chamber is opened, the pressure will be equalised. The gas that passes by the ice condenser produces an extremely fine ice mist inside the drying chamber. This ice mist enters into all of the vials, thereby causing immediate and homogeneous freezing.

LyoControl measuring system

The Lyo Control measuring system can be used to determine the crystallisation state of the product. In the liquid state, the electrical resistance is very low. During the freezing process, the resistance increases. The LyoRx control sensor measures the electrical resistance.

LyoLogplus data logging software

LyoLogplus is a data logging software program by Martin Christ Gefriertrocknungsanlagen GmbH that is specifically adapted to the requirements of freeze-drying processes. Apart from the graphical representation of the measurement data of currently running processes, it also enables the data export for additional evaluation.

LPCplus SCADA system

The Christ LPCplus system consists of the Supervisory Control And Data Acquisition (SCADA) software program by Martin Christ Gefriertrocknungsanlagen GmbH and a dedicated PC. The system is connected to the LSCplus controller of the freeze-dryer via Ethernet and provides the operation of all of the freeze-drying functions as well as process recording (measurement data and process events), process documentation and data backup. Furthermore, it enables the comfortable administration of freeze-drying programs/recipes and users.

6.9 Switching the freeze-dryer OFF

The freeze-dryer must be in the standby status.

- Switch the control system off by pressing the control switch.
- Pressing the main switch disconnects the freeze-dryer from the power.

7 Malfunctions and error correction

Malfunctions are displayed in the dialogue box "Process & equipment messages" (see chapter 7.2 - "Process and error messages"). An acoustic signal sounds when an error message is generated.

- Eliminate the source of the problem (see the following chapter).
- Acknowledge the error message.

7.1 General malfunctions

Type of error	Possible reason	Correction
No indication on the display	<ul style="list-style-type: none"> • No power in the mains supply (see chapter 7.1.1 - "Power failure"). • Power cord is not plugged in. • Fuses have tripped. • The control switch is set to off. • The main switch is set to off. 	<ul style="list-style-type: none"> • Check the mains power supply fuse. • Plug in the power cord correctly. • Check the on-site fuses. • Switch the control switch on. • Switch the main switch on.
The touchpanel does not react at all or it does not react correctly	<ul style="list-style-type: none"> • The sensitivity of the touchpanel is misadjusted. 	<ul style="list-style-type: none"> • Contact the service department (see chapter 7.3 - "Service contact")
The password input fails	<ul style="list-style-type: none"> • The password is not correct. 	<ul style="list-style-type: none"> • Inform the administrator. • If you have lost the administrator password: contact the service department (see chapter 7.3 - "Service contact")
Insufficient vacuum	<ul style="list-style-type: none"> • Incorrect connection of the small flange connection(s). 	<ul style="list-style-type: none"> • Loosen the connection. Place the centring ring with the inner sealing ring in a centred manner between the flange connections and connect it with the clamping ring. Ensure that the centring ring neither slips out of place nor gets jammed.
	<ul style="list-style-type: none"> • Dirty or damaged door seal. 	<ul style="list-style-type: none"> • Clean the door seal and replace it if necessary.
Leakage in the media drain valve	<ul style="list-style-type: none"> • The media drain valve is soiled with drying residues or wool particles from cleaning cloths. • The O-rings are worn. 	<ul style="list-style-type: none"> • Clean the media drain valve (see chapter 8.1.4 - "Aeration valve, media drain valve") and replace it if necessary. • Replace the O-rings.
The displayed vacuum value is not correct	<ul style="list-style-type: none"> • Incorrect calibration • The vacuum sensor is soiled (e.g. due to water residues). • The vacuum sensor is defective. 	<ul style="list-style-type: none"> • Calibrate the vacuum sensor (see the separate operating instructions of the vacuum sensor). • Clean the vacuum sensor. • Check the vacuum display with the aid of a reference device (if available). • see chapter 7.1.2.4 - "Vacuum sensor"

7 Malfunctions and error correction

Type of error	Possible reason	Correction
The vacuum pump is not activated	<ul style="list-style-type: none"> See the separate operating instructions of the vacuum pump. 	<ul style="list-style-type: none"> See the separate operating instructions of the vacuum pump.
Insufficient ice condenser or shelf temperature	<ul style="list-style-type: none"> The overpressure switch of the refrigeration unit has tripped. The thermal circuit breaker has tripped. 	<ul style="list-style-type: none"> Let the unit cool down. Ensure sufficient air circulation (see chapter 7.1.3 - "Insufficient ice condenser temperature")
The error message "Refrigeration unit x.x overpressure" is displayed during a freeze-drying process	<ul style="list-style-type: none"> Leakage on the low pressure side (suction side) of the refrigeration system leads to a pressure increase 	<ul style="list-style-type: none"> Acknowledge the message. If the message is displayed repeatedly, inform the service department (see chapter 7.3 - "Service contact")



If it is impossible to eliminate the errors, contact the Christ service department!

7.1.1 Power failure

The control system continues with the process after a power failure. The preselected conditions remain saved even during a process run.

In the event of a power failure in the drying phase, the batch may become unusable. Whether the batch can be saved or not depends on the drying phase in which the product was when the power failure occurred.

- In the final drying phase, the product has reached a residual moisture content of approx. 5%. Below this value, the product is generally not damaged even if the power failure lasts for a longer period of time.
- If the product is in the main drying phase, we recommend aerating the unit, removing the product, and storing it in a deep-freeze. The defrosted condensate must be drained off prior to the next start.

7.1.2 Insufficient vacuum

The vacuum checks must be carried out when the ice condenser is frozen.

7.1.2.1 Small flange connections

Leakages are often due to improper small flange connections between the various components and hose connections or to leakages in the valves.

- Loosen the connection and place the centring ring (with sealing ring inside) in a centred manner between the flange connections.
- Seal the connection with the clamping ring by tightening the wing nut.
- Ensure that the centring ring neither slips out of place nor gets jammed.

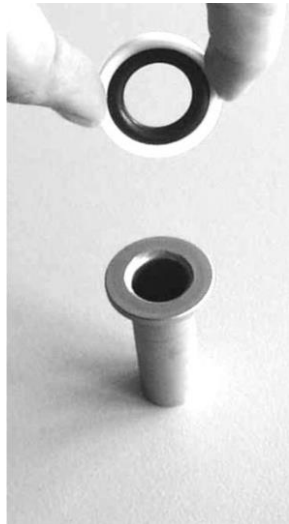

Fig. 75: Small flange and centring ring

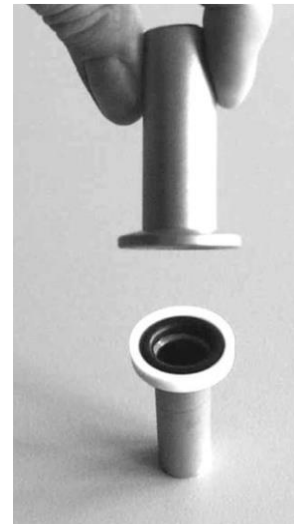

Fig. 76: Small flange with centring ring and small flange



Fig. 77: Attaching the clamping ring



Fig. 78: Tightened clamping ring

7 Malfunctions and error correction

7.1.2.2 Aeration valve, media drain valve



WARNING

Risk of poisoning/infection caused by contaminated condensate (defrosting water)

The condensate may contain harmful substances originating from the product.

Contact with the condensate may cause severe damage to health.

- Wear suitable protective clothes, gloves, and respiratory protection when maintaining the drain system (especially when cleaning the valves and when replacing the seals)!

A malfunction of the aeration valve or the media drain valve may have several causes. One potential source are contaminants such as product residues within the valve.

- Switch the freeze-dryer off and disconnect the mains plug.
- Clean the valve (see chapter 8.1.4 - "Aeration valve, media drain valve").
- Put the freeze-dryer into operation again.

If there is still a leakage, the freeze-dryer must be checked by qualified specialist personnel (see chapter 7.3 - "Service contact").

7.1.2.3 Pressure control valve

A malfunction of the pressure control valve may have several causes.



NOTE

The inspection of the valve must be carried out by qualified specialist personnel (see chapter 7.3 - "Service contact").

7.1.2.4 Vacuum sensor

Vacuum sensors have a limited service life and can be ordered as spare parts.

Capacitive vacuum sensors

Capacitive vacuum sensors may experience a measurement drift due to long-term use, soiling or sudden aeration. In this case, the vacuum sensor must be adjusted (see chapter 8.1.11 - " Vacuum sensor ").

7.1.3 Insufficient ice condenser temperature

**CAUTION**

Ensure sufficient ventilation. Do not place any paper, cloth, or similar material behind or under the unit, since otherwise the air circulation will be impaired.

**NOTE**

The refrigeration units are activated with a certain time lag. Refrigeration unit 2 is solely intended for the heat exchanger. It enables the control of the shelf temperature via the heat transfer medium. Refrigeration unit is primarily intended for cooling the ice condenser. However, if more cold is required on the shelves (especially during freezing), it will be temporarily switched over to the heat exchanger, which leads to an increasing ice condenser temperature.

An increase of the ice condenser temperature during the freezing phase is a regular part of the freeze-drying process.

The refrigeration unit is equipped with a protective device against overpressure in the refrigeration system and with a thermal motor protection switch.

The protective devices trip

- when the ambient temperature is too high
- when the air circulation of the heat exchanger of the refrigeration system is insufficient
- when the refrigeration system is overloaded.

In these cases, the refrigeration unit will be switched off automatically. If the permissible operating conditions are re-established after a cool-down phase of several minutes, the refrigeration unit will be switched on again automatically.

The malfunctions are displayed in the process and equipment information window.

The minimum ice condenser temperature of approx. -85°C is reached when the ice condenser is not loaded and the ice condenser chamber is evacuated.

7.2 Process and error messages

The control system displays the complete process and error messages (see chapter 6.7.1.1 - "Main window "Manual", dialogue box "Process and equipment messages"), which is why they are not included in this operating manual.

You can order these documents from our service department.

7 Malfunctions and error correction

7.3 Service contact

In the event of queries, malfunctions, or spare part enquiries:

From Germany:

Contact

Martin Christ Gefriertrocknungsanlagen GmbH

An der Unteren Söse 50

37520 Osterode (Germany)

Tel. +49 (0) 55 22 / 50 07-33 33

E-mail: support.epsilon@martinchrist.de

Outside Germany:

Contact our agency in your country. All agencies are listed at

www.martinchrist.de → [Sales Partners]



- If you would like to utilise our after-sales-service, please state the type of your freeze-dryer and its serial number.

8 Maintenance and service

The freeze-dryer and the accessories are subject to high mechanical and chemical stress. Thorough maintenance performed by the user extends the service life and prevents premature failure.



CAUTION

If corrosion or other damage occurs due to improper care, the manufacturer cannot be held liable or subject to any warranty claims.

- Thoroughly clean the freeze-dryer immediately after use to prevent or at least significantly reduce the damage to the materials of construction (see also chapter 1.3 - "Intended use", section "Freeze-drying of solvent-containing products").
- Use soap water or other water-soluble, mild cleaning agents for cleaning the freeze-dryer and the accessories.
- Do not use corrosive and aggressive substances.
- Do not use solvents.
- Do not use agents with abrasive particles.
- Do not expose the freeze-dryer or its accessories to intensive UV radiation (e.g. sunlight) or thermal stress (e.g. by heat generators).

8.1 Maintenance

8.1.1 General

The general state of the freeze-dryer must be checked at regular intervals. Any defects must be eliminated immediately! The following points are of particular importance:

- dirt,
- leaks,
- corrosion,
- bent system components,
- loose screw and flange connections,
- higher noise levels,
- loose cables,
- open cable ducts,
- missing or illegible safety notes and hazard warnings,
- missing or illegible inscriptions on components, pipes (direction of flow) and cables,
- etc.

8 Maintenance and service

Cleaning of the freeze-dryer



WARNING

Risk of burns on hot surfaces

Housing of the freeze-dryer

During the operation of the freeze-dryer and half an hour afterwards, the outer surface of the freeze-dryer (especially the pipes and units) may still be hot.

Inside the chamber:

After a drying process, some or all of the surfaces inside the chamber (chamber walls, shelves, intermediate valve, etc.) may still be hot.

There is a risk of burns when touching the surfaces.

- Wear suitable protective clothes and gloves!
- Do not touch the surfaces on purpose!



DANGER

Risk of poisoning/infection caused by the products

When performing maintenance work on parts coming into contact with the product (e.g. all parts inside the chamber, vacuum pump), the personnel may be exposed to product residues.

Skin contact or the inhalation of particles may cause severe damage to health depending on the product in question.

- Take suitable decontamination measures prior to commencing the maintenance!
- Wear suitable protective clothes and gloves!

- Switch the freeze-dryer off by actuating the mains power switch and disconnect the power cord from the wall outlet before cleaning.
- If the freeze-dryer has been contaminated with toxic, radioactive, or pathogenic substances, clean the inside immediately with a suitable decontamination agent (depending on the type of contamination, see chapter 8.2 - "Disinfection of the drying chamber and accessories").
- Remove product residues thoroughly with a cloth.
- Open loading door when the freeze-dryer is not in use so moisture can evaporate.

8.1.2 Ice condenser chamber



WARNING

Risk of poisoning/infection caused by contaminated condensate (defrosting water)

The condensate may contain harmful substances originating from the product.

Contact with the condensate may cause severe damage to health.

- Wear suitable protective clothes, gloves, and respiratory protection when maintaining the drain system (especially when cleaning the valves and when replacing the seals)!

Before each start-up, ensure that the ice condenser chamber is free from water residues.

- Open the media drain valve to drain off any liquid. Then, close the valve.
- If necessary, wipe the ice condenser chamber dry with a cloth.

8.1.3 Drying chamber

In order to avoid corrosion and negative effects on a subsequent freeze-dryer process, it must be ensured that there is no water left inside the drying chamber after every freeze-drying process.

- If necessary, wipe the chamber dry with a cloth.

8.1.3.1 Lamination of the loading door with a special film

Freeze-dryers with an acrylic glass door are equipped with the special Radiation Shield film on the exterior side of the acrylic glass door. In addition, a Solvent Shield film can be installed on the interior side of the door (see chapter 6.5 - "Loading door").



NOTE

For technical reasons, inclusions are possible. However, they do not prevent the film from performing its function.



NOTE

In the case of acrylic glass doors with a Radiation Shield film, visible light reflexions are possible. This is not a defect but rather the natural consequence of the high-performance film.

To prevent the film from being damaged, compliance with the following points is mandatory for cleaning:

- In case of a contamination with toxic, radioactive or pathogenic substances, clean immediately with a suitable decontamination agent (see chapter 8.2 - "Disinfection of the drying chamber and accessories").
- Clean with plenty of water immediately after use to ensure that contaminants are flushed off and not wiped off.

8 Maintenance and service



CAUTION

Do not clean the film while dry.

- Use soft cloths, soft sponges made of synthetic fibres or rubber squeegees and common household cleaning agents (glass cleaner) for cleaning. The cleaning agents must be free from abrasive agents.
- Do not use hard sponges, cloths or brushes for cleaning.
- Avoid strong mechanical stress during cleaning.

8.1.3.2 Special equipment: Stainless steel door latch at the loading door

Systems that are equipped with a stainless-steel or acrylic glass door with a stainless-steel door latch have a slide pad on the door latch. This slide pad is included in the scope of supply as a spare part. It must be inspected regularly for signs of wear. When its thickness is < 0.5 mm, it must be replaced.

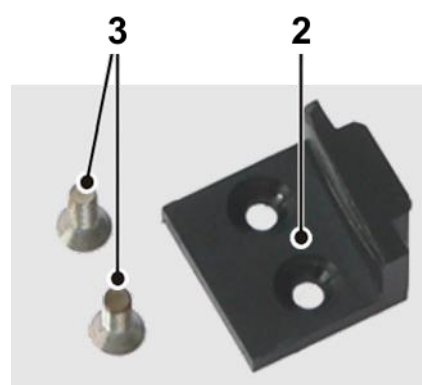
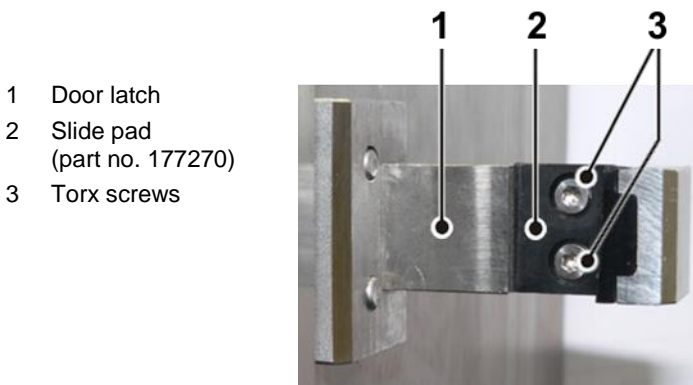

Fig. 79: Door latch and slide pad

Replacing the slide pad:

Unscrew the two screws of the slide pad with a Torx® TX10 screwdriver, remove the old slide pad, and install the new one.

8.1.4 Aeration valve, media drain valve

WARNING
Risk of poisoning/infection caused by contaminated condensate (defrosting water)

The condensate may contain harmful substances originating from the product.

Contact with the condensate may cause severe damage to health.

- Wear suitable protective clothes, gloves, and respiratory protection when maintaining the drain system (especially when cleaning the valves and when replacing the seals)!

Contaminants such as product residues may lead to an insufficient vacuum. In this case, the aeration valve and the media drain valve must be cleaned.

- Switch the freeze-dryer off and disconnect the mains plug.
- Remove the valve core.
- Clean the valve core and the opening with a moist cloth.
- Clean the O-rings and inspect them for any damage. Damaged O-rings must be replaced.

- 1 Valve opening
- 2 Valve core
- 3 O-rings

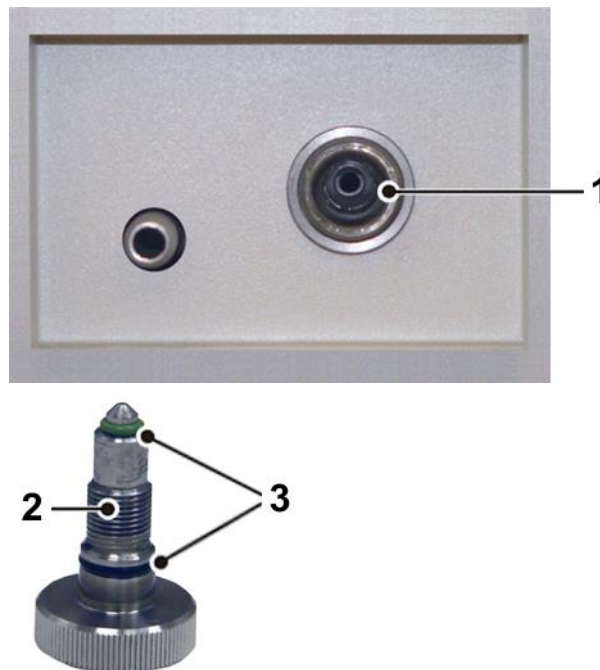

Fig. 80: Valve opening and valve core with O-rings
(example, varies depending of the type of freeze-dryer)

- Reinsert the valve core.
- Put the freeze-dryer into operation again.

If the vacuum is still insufficient, the freeze-dryer must be checked by qualified specialist personnel (see chapter 7.3 - "Service contact").

8 Maintenance and service

8.1.5 Heat exchanger (only air cooled freeze-dryers)

A lamellar heat exchanger is used for cooling the refrigerant that is compressed by the refrigeration unit. This air-cooled heat exchanger is located at the back of the unit (see chapter 7.3 - "Service contact").

Dust and dirt impair the cooling effect of the air flow. Dust on the lamellas prevents the exchange of heat and, thereby, impairs the performance and power of the refrigeration unit. Strong soiling may cause the unit to fail.

This is why the selected set-up location should be as clean as possible.

- Check the heat exchanger at least once per month for soiling and clean it if necessary.
- Please contact the Christ service department if you have any queries (see chapter 7.3 - "Service contact").

8.1.6 Electrical system



DANGER

Danger of life caused by electric shock

There is a risk of electric shock when touching current-carrying components.

This may lead to ventricular fibrillation, cardiac arrest, or respiratory paralysis.

- Only qualified electricians are authorised to perform work on the electrical system of the freeze-dryer!

The electrical equipment of the freeze-dryer must be checked at regular intervals by a qualified electrician. Defects such as loose connections or burnt cables must be eliminated immediately.

8.1.7 Vacuum system

Please refer to the maintenance instructions of the vacuum pump and exhaust gas filter in the enclosed operating instructions of the manufacturer!



WARNING

Risk of burns on hot surfaces

During the operation of the freeze-dryer and half an hour afterwards, the outer surface of the vacuum pump may be hot.

There is a risk of burns when touching the surfaces.

- Wear suitable protective clothes and gloves!
- Do not touch the surfaces on purpose!



WARNING

Risk of scalding caused by the vacuum pump oil

When working on the vacuum pump and exhaust gas filter (especially when changing the oil or filter), the maintenance personnel are exposed to the hot vacuum pump oil.

There is a risk of scalding in the event of skin contact.

- Wear suitable protective clothes and gloves!
- Use a suitable collecting vessel!



WARNING

Risk of poisoning/infection caused by the vacuum pump oil

When working on the vacuum pump and exhaust gas filter (especially when changing the oil or filter), the maintenance personnel are exposed to the vacuum pump oil, which may contain harmful substances originating from the product. In addition, synthetic oils can release toxic fumes when they are ignited or heated above 300°C.

The inhalation of the fumes that are released by the oil, or contact with the skin, can cause severe damage to health.

- Wear suitable protective clothes, gloves, and respiratory protection!
- Ensure the environmentally sound disposal of the oil in compliance with the local rules and regulations!
- Do not let the oil come into contact with tobacco products!

The stress of the vacuum pump in conjunction with a freeze-dryer is usually not very high. This is why the recommendations in this operating manual may differ from the information that is provided by the pump manufacturers. Under normal operating conditions, the following maintenance tasks concerning the vacuum pump must be performed at regular intervals:

- Check the oil level of the vacuum pump once per week. If necessary, top it up with oil.
- Check the running pump for any unusual noise.
- Ensure that the pump has reached its operating temperature prior to changing the oil. If the oil is cloudy, shows particles or is discoloured, an oil change must be performed.
- Perform the first oil change after approximately 100 operating hours.
- The other oil changes depend on the operating conditions. In general, an interval of 500 to 1,000 operating hours is sufficient.
- Please contact the Christ service department if you have any queries (see chapter 7.3 - "Service contact").

8 Maintenance and service

8.1.8 Refrigeration system



DANGER

Risk of suffocation caused by the refrigerant

When work is performed on the refrigeration system of the freeze-dryer, refrigerant may escape in the liquid or gas state and under high pressure. Gaseous refrigerant is heavier than air and high concentration levels of it may collect on the floor or in pits.

There is a risk of suffocation in the case of high concentration levels. Possible symptoms are paralysis and unconsciousness. Affected persons do not notice the fact that they suffocate.

- Only qualified persons are authorised to perform work on the refrigeration system of the freeze-dryer!
- Ensure good aeration/extraction when working on the refrigeration system!



WARNING

Risk of cold burns or frostbite caused by the refrigerant

When work is performed on the refrigeration system of the freeze-dryer, refrigerant may escape in the liquid or gas state and under high pressure. In the case of skin contact with liquid refrigerant, cold burns or frostbite may result.

- Only qualified persons are authorised to perform work on the refrigeration system of the freeze-dryer!



DANGER

Risk of explosion due to refrigerants (natural, flammable refrigerants)

The natural refrigerants used are highly flammable and can form an explosive mixture if their concentration in the ambient air is sufficiently high.

There is an explosion hazard.

- Work on the refrigeration system of the freeze-dryer must only be carried out by qualified specialist personnel who have been trained to handle flammable refrigerants!
- Ensure good ventilation and make sure that no ignition sources (e.g. soldering iron, welding equipment) are present!



WARNING

Risk of poisoning caused by the refrigerant (non-flammable refrigerants)

During its decomposition (e.g. due to naked flames or hot surfaces), hazardous/toxic gases are released.

Contact with the decomposition products may cause severe damage to health.

- Only qualified persons are authorised to perform work on the refrigeration system of the freeze-dryer!
- Do not eat, drink, or smoke when working on the refrigeration system!

The refrigerant circuit is a closed system. Only certified and qualified persons are authorised to perform work on the refrigeration system!

8.1.9 Heat transfer medium system

The filling level of the heat transfer medium for the temperature control of the shelves can be checked via the sight glass (position see chapter 2.1.1 - "Functional and operating elements"). This check is performed only once per month. Even in the case of several years of use, the heat transfer medium usually does not need to be topped up.

The circulation pump for the heat transfer medium is maintenance-free.

8.1.10 Hydraulic system



Risk of a high pressure injection with hydraulic oil

When working on the hydraulic system of the freeze-dryer, or due to the ageing of the hose lines, hydraulic oil may escape.

Due to the high pressure, the oil may penetrate the skin. This may lead to severe injuries with the risk of embolism.

- Only qualified persons are authorised to perform work on the hydraulic system of the freeze-dryer.

Have the hoses and screw fittings checked for leaks by a specialist at regular intervals and replace them immediately if they are damaged. Replace the hydraulic hose lines at appropriate intervals (depending on the operating conditions and under consideration of the specifications and recommendations of the manufacturer) even if no safety-relevant defects can be noticed.

8.1.11 Vacuum sensor



Please refer to the separate operating manual of the vacuum sensor!

The vacuum sensor has only a limited service life. Especially carbon-containing substances, e.g. alcoholic compounds, reduce the service life extremely.

- The vacuum sensor is maintenance-free.
- Remove any soiling on the outside with a cloth.

Capacitive vacuum sensors

Measurement drift due to long-term use, soiling or sudden aeration may occur.

- Capacitive vacuum sensors must be adjusted at least once per year. Depending on the actual conditions of use, shorter adjustment intervals may be necessary.

8 Maintenance and service

8.1.12 Accessories



CAUTION

For the care of the accessories, special safety measures must be considered as these are measures that will ensure operational safety at the same time.

Chemical reactions as well as stress-corrosion (combination of oscillating pressure and chemical reaction) can affect or destroy the metal and plastic parts. Barely detectable cracks on the surface can expand and weaken the material without any visible signs.

- Check the material regularly (at least once a month) for
 - cracks
 - visible damage of the surface
 - pressure marks
 - signs of corrosion
 - other changes.
- Replace any damaged components immediately for your own safety.
- Immediately rinse off the accessories if any liquids that may cause corrosion come into contact with them.
- Clean the accessories outside the freeze-dryer once a week or preferably after each use.

8.2 Disinfection of the drying chamber and accessories



DANGER

If dangerous materials (e.g. infectious and pathogenic substances) are used, the freeze-dryer and accessories must be disinfected.

- Use commercially-available disinfectants such as, for example, Incidur[®], Meliseptol[®], Sagrotan[®], Buraton[®], or Terralin[®] (available at specialised trade).
- The freeze-dryers and the accessories consist of various materials. A possible incompatibility must be considered.
- Before using cleaning or decontamination agents that were not recommended by us, contact the manufacturer to ensure that such a procedure will not damage the freeze-dryer.
- Please contact us if you have any queries (see chapter 8.4 - "Service").

8.3 Maintenance schedule

System/ Component	Detail / Part	Inspection		Periodical Maintenance				Repair/Rebuild
		before start	daily	inspection	replace	operation	calibration	
Drying Chamber - Operator Side	Drying chamber: dry and clean	X		X				
	Steel bellow: clean and undamaged	X		X		smooth travel		
	Silicone oil hoses and	X		X		leak free		
	Intermediate valve gasket	X		X	after 50 sterilisations			
	Shelves: pins	X		burr-free		smooth travel		
	Shelves: surface clean and undamaged	X						
	Shelves: guardrails	X						
	Acrylic door surface	X		fogging, cracks				
	Door gasket: clean and undamaged	X		replace	after 50 sterilisations			Changing procedure
	Door locks	X		burr-free		X		Changing procedure
	Hinges	X		X		X		Adjust hinges after replacing door gasket
	Door cover: securely attached	X		X				
	Chamber sight glasses: clean, illumination ok	X		X				
	Machine Room - General	Electrical cabinet		X	X			
Leakages			X	X				
Noise emission during operation			X	X				
Dynamic gaskets: diaphragms					after 100 sterilisations			
Static seals: O-rings, clamp, KF					after 100 sterilisations			
Loose wire				X				
Cable tray closed				X				
Framework				corrosion				Remove corrosion
Aeration filter					after 50 sterilisations			
Vacuum System	Pump: oil level	X	X	X				
	Pump: oil condition (colour, contamination)	X	X	X	oil change			
	Oil mist filter: emission of oil mist		X	X		X		
	Oil mist filter: oil level		X			cleaning		
	Final vacuum of instrument					X		
	Residue / particles inside oil casing			X				
	Oil leakages at pump	X		X	after 10 years			Rotary shaft seal, bearings, vanes, springs: service life of 10 years
	Vacuum leakage test					X		

8 Maintenance and service

System/ Component	Detail / Part	Inspection		Periodical Maintenance				Remarks
		before start	daily	inspection	replace	operation	calibration	
Refrigeration System	Ice formation			X				
	Leakage test according to EU 842/2006 (with more than 3 kg refrigerant)							
	Heat exchanger			X		cleaning		
	Pressure readings / performance tests					X		
	Noise emission above average			X				
	Solenoid valves					X		
	Ice condenser temp.: low end					X		
	Cooling water control valves			X		X		Clean regulation device
Liquid System / Silikon Oil Circuit	Expansion vessel: liquid level		X	X		X		
	Soaked insulation by silicone oil		X	X				
	Trigger point over temperature					X		
	Temperature gages: positioning			X				
	Drying cartridge (adsorption filter)			X				
Instrumentation	Vacuum sensor(s)						X	
	Temperature points at FD						X	
	Pressure sensors chamber						X	
	Product temperature					X	X	Changing procedure
	Level switches					X		
	Solenoid valves			X		X		
Hydraulic System	Leakages		X	X				
	Max pressure reading					X		
	Oil in reservoir	X		X				
	Hydraulic hoses			X	after 5 years			
	Cylinder travel speed					X		
Electrical Installation	Cabinet: temperature inside			X		X		
	Cabinet: components			X				
	Cabinet: cooling system			X	Filter after 1 year	X		
	Wiring			X				
	Power reading of components					X		
	PLC backup battery				2 years			
	Alarm system (horn, light)					X		

8.4 Service



DANGER

In the event of service work that requires the removal of the panels, there is a risk of electric shock or mechanical injury. Only qualified specialist personnel is authorised to perform this service work.

The freeze-dryer is subject to high mechanical stress. In order to be able to withstand this high level of stress, high-quality components were used during the production of the freeze-dryer. Nevertheless, wear cannot be excluded and it may not be visible from the outside.

This is why we recommend having the freeze-dryer checked by the manufacturer during an inspection once per year.

Information and appointments:

From Germany:

Contact

Martin Christ Gefriertrocknungsanlagen GmbH

An der Unteren Söse 50

37520 Osterode (Germany)

Tel. +49 (0) 55 22 / 50 07-33 33

E-mail: support.epsilon@martinchrist.de

Outside Germany:

Contact our agency in your country. All agencies are listed at www.martinchrist.de → [Sales Partners]



NOTE

If you would like to utilise our after-sales-service, please state the type of your freeze-dryer and its serial number.

8.5 Return of defective parts

Although we exercise great care during the production of our products, it may be necessary to return a unit or accessory to the manufacturer.

In order to ensure the quick and economical processing of returns of freeze-dryers, rotational vacuum concentrators, spare parts, or accessories, we require complete and extensive information concerning the process. Please fill in the following forms completely, sign them, enclose them with the return package, and send them together with the product to:

Martin Christ Gefriertrocknungsanlagen GmbH

An der Unteren Söse 50

37520 Osterode (Germany)

8 Maintenance and service

1. Declaration of decontamination

As a certified company and due to the legal regulations for the protection of our employees and of the environment, we are obliged to certify the harmlessness of all incoming goods. For this purpose, we require a declaration of decontamination.

- The form must be filled in completely and signed by authorised specialist personnel only.
- Affix the original form in a clearly visible manner to the outside of the packaging.



We will return the part/unit if no declaration of decontamination is provided!

2. Form for the return of defective parts

This form is for the product-related data. They facilitate the assignment, and they enable the quick processing of the return. If several parts are returned together in one packaging, please enclose a separate problem description for every defective part.

- A detailed problem description is necessary in order to perform the repair quickly and economically.
- Upon request, we will prepare and submit to you a cost estimate prior to performing the repair. Please confirm such cost estimate within 14 days. If the cost estimate has still not been confirmed after 4 weeks, we will return the defective part/unit. Please note that you must bear the incurred costs.



The part/unit must be packaged in a transport-safe manner. Please use the original packaging for the unit, if at all possible.

If the product is dispatched to us in unsuitable packaging, you will be charged the cost for returning it to you in new packaging.

The forms can be downloaded online from www.martinchrist.de → [Service] → [Overhaul, repair and leak testing].

9 Disposal

9.1 Disposal of the freeze-dryer

Martin Christ Gefriertrocknungsanlagen GmbH is a registered manufacturer of electric and electronic devices that are solely intended for commercial use.

- Comply with all local rules and regulations.

9.2 Disposal of the packaging

- Dispose of the packaging, after having separated the individual materials.
- Comply with all local rules and regulations.

10 Technical data

10 Technical data

Manufacturer:	Martin Christ Gefriertrocknungsanlagen GmbH An der Unteren Söse 50 37520 Osterode (Germany)
Type:	Epsilon 2-10D LSCplus
Part number:	110825
Physical data (without vacuum pump)	
Dimensions of the unit	
- Height:	1,303 mm
- Width:	1,190 mm
- Depth:	866 mm + 100 mm vacuum connection
Weight:	approx. 665 kg
Noise level according to DIN 45635:	64 dB (A)
EMC according to EN 55011:	Class B
Heat emission:	3.0 kW min. 5.6 kW max.
Refrigeration system	
Ice condenser:	Cascade system with 2 compressors 1.2 kW each
Shelf temperature control:	1 compressor 0.9 kW
Filling quantity	
<u>Natural, flammable refrigerant</u>	Filling quantity / CO ₂ equivalent
Refrigeration circuit 1	
- R1270:	140 g / < 0.01 t
- R170:	116 g / < 0.01 t
Refrigeration circuit 2	
- R404A	100 g / < 0.01 t
<u>Non-flammable refrigerant</u>	Filling quantity / CO ₂ equivalent
Refrigeration circuit 1	
- R290:	16 g / < 0.01 t
- R404A:	650 g / 2.46 t
- R508B:	270 g / 3.62 t
Refrigeration circuit 2	
- R404A	1,200 g / 4.54 t
<u>Heat transfer medium</u>	
- Fragoltherm X-T15:	approx. 15 l
Performance data	
<u>Ice condenser chamber</u>	
- Dimensions (W x H x D):	460 mm x 470 mm x 231 mm
- Volume:	approx. 50 l
<u>Ice condenser</u>	
- Capacity:	10 kg max.
- Performance:	8 kg / 24 h max.
- Temperature:	approx. -85°C
<u>Drying chamber</u>	
- Dimensions (W x H x D):	460 mm x 470 mm x 470 mm
- Volume:	approx. 100 l

10 Technical data

Performance data	
<u>Shelves</u>	
- Dimensions (W x D):	350 mm x 400 mm
- Max. shelf surface area:	see table below
- Distance between shelves:	see table below
- Shelf temperature:	approx. -55°C to +60°C
- Shelf temperature accuracy:	±1°C max. on one shelf and from shelf to shelf
<u>Vacuum</u>	
- Final vacuum, double stage:	5 x 10 ⁻³ mbar
- Leak rate (test time 12-15 h):	5 x 10 ⁻³ mbar / sec
Connection requirements	
Electrical connection:	3 x 400 V / 50 Hz (other supply data on request)
Protection class:	I
IP protection category according to DIN 60529:	11
Apparent power	
- with vacuum pump Vacuubrand RZ 9 (1 ph):	6.8 kVA
Nominal current:	12.0 A
Mains fuse:	16.0 A
Equipment connections	
Aeration:	Hose nozzle DN6 (outside diameter 10 mm max.)
Drain (standard):	Hose nozzle DN10 (outside diameter 12 mm)
Special equipment:	
Drain at the connector block:	R3/4"
Vacuum connection:	Stainless steel pipe, Ø 20 mm
Mains input:	CEE plug (16 A 3ph)
Data interface (LAN):	RJ 45
Special equipment: water cooling system	
Part number:	110827
Water feed flow temperature:	+15°C to +20°C
Water return flow temperature:	25°C max.
Water temperature difference:	10K max. with +15°C feed flow temperature 5K max. with +20°C feed flow temperature
Cooling water pressure:	2 bar min. 10 bar max. Δp min. 1.5bar
Volumetric flow rate:	0.7 m ³ /h (≈ 11.7 l/min) max.
Heat dissipated by cooling water:	5,600 W
Cooling water feed flow connection:	R3/4" with hose nozzle DN 13
Attention! When the unit is switched off, the water feed flow must be shut off by the customer!	
Cooling water return flow connection:	R3/4" with hose nozzle DN 13
Option: cooling water flow controller (factory setting):	12 bar (refrigeration unit, high pressure side)

10 Technical data

Shelves														
Shelf width:		350	R-vials		2R	4R	6R	8R	10R	15R	20R	25R	30R	
Shelf length:		400	↓ mm		35	45	40	45	45	60	55	65	75	
Shelf ↓		15	∅ mm		16	16	22	22	24	24	30	30	30	
Number of shelves		Area	Distance		The data indicate the maximum loading. Subtract 10% when using frames!									
1	+	1	0,14	354		613	613	326	326	266	266	165	165	165
2	+	1	0,28	169		1226	1226	652	652	532	532	330	330	330
3	+	1	0,42	108		1839	1839	978	978	798	798	495	495	495
4	+	1	0,56	77		2452	2452	1304	1304	1064		660		
5	+	1	0,70	59	Standard	3065								
6	+	1	0,84	47	Only trays									
7	+	1	0,98	38	Only trays									

				H-vials	5H	7H	8H	10H	15H	20H	25H	30H	50H	100H	
				↓ mm	41	41	47	54	59	58	58	63	73	95	
				∅ mm	21	22	23	25,5	27	32	36	36	43	52	
Number of shelves		Area	Distance		The data indicate the maximum loading. Subtract 10% when using frames!										
1	+	1	0,14	354		363	326	290	243	218	147	117	117	83	54
2	+	1	0,28	169		726	652	580	486	436	294	234	234	166	108
3	+	1	0,42	108		1089	978	870	729	654	441	351	351	249	
4	+	1	0,56	77		1452	1304	1160	972	872	588	468			
5	+	1	0,70	59	Standard										
6	+	1	0,84	47	Only trays										
7	+	1	0,98	38	Only trays										

10.1 Ambient conditions

- Use in closed spaces
- Altitudes up to 2,000 m
- Ambient temperature between +5°C and +25°C
- Maximum relative humidity of 80%
- Mains voltage fluctuations of up to ± 10% of the rated voltage

10.2 Technical documentation

The technical documentation of this freeze-dryer (e.g. circuit diagram, cooling system) and the safety data sheets of the manufacturers (e.g. for refrigerant) is not attached to this operating manual.

You can order these documents from our service department.

11 Appendix

11.1 Mathematical relations

The automatic processes in the "Programmer module" menu (see chapter 6.7.3 - "Freeze-drying with the PGMplus programmer module") are based on the following considerations:

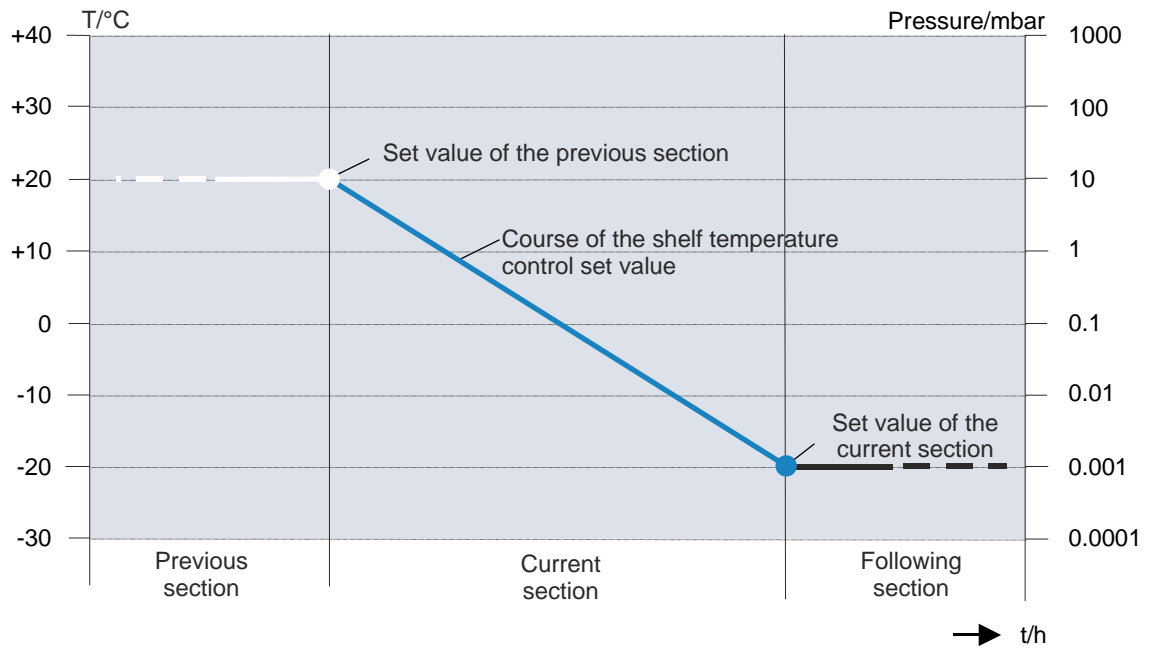

Fig. 81: Graphical representation of the course of the control set value

Calculation of the control set value and of the gradient for the temperature:

$$\text{gradient} = \frac{\text{set value of current section} - \text{set value of previous section}}{\text{section time of current section}} \quad [^{\circ}\text{C}/\text{min}]$$

$$\text{control set value} = \text{set value of previous section} + \text{elapsed section time} \cdot \text{gradient} \quad [^{\circ}\text{C}]$$

Example:

Section	Set values	
	Section time [h:min]	Temperature [°C]
Preceding	...	30
Current	1:00	60

$$\text{gradient} = \frac{60^{\circ}\text{C} - 30^{\circ}\text{C}}{60 \text{ min}} = \frac{30^{\circ}\text{C}}{60 \text{ min}} = 0.5^{\circ}\text{C}/\text{min}$$

After an elapsed section time of 30 minutes, for example, the control set value for the temperature is:

$$\text{Control set value}_{(t=30\text{min})} = 30^{\circ}\text{C} + 30\text{min} \cdot 0.5^{\circ}\text{C}/\text{min} = 45^{\circ}\text{C}$$

Calculation of the control set value for the vacuum:

$$\text{control set value} = 10^{\text{LOG10}(\text{set value prev. sect.}) + \left(\frac{\text{LOG10}(\text{set value current sect.}) - \text{LOG10}(\text{set value prev. sect.})}{\text{section time of current section}} \right) \cdot \text{elapsed section time}} \quad [\text{mbar}]$$

11 Appendix

11.2 EC declaration of conformity in accordance with the EC Machinery Directive



EC – DECLARATION OF CONFORMITY

in accordance with the EC Machinery Directive 2006/42/EC, annex II, part 1, section A

The product named hereinafter was developed, designed, and manufactured in compliance with the relevant, fundamental safety and health requirements of the listed EC directives and standards.

In the event of modifications that were not authorised by us or if the product is used in a manner that is not in line with the intended purpose, this declaration will be rendered void.

Product name:	Freeze-dryer
Product type:	Epsilon 2-10D LSCplus
Order number:	110825, 110826, 110827, 110828, 110837, 110839
Directives:	2006/42/EG Machinery Directive 2014/35/EU Low Voltage Directive 2014/30/EU EMC Directive 2014/68/EU Pressure Equipment Directive
Underlying standards:	DIN EN ISO 12100:2011-03 DIN EN 378-1 bis 378-4:2012-08 DIN EN ISO 13849-1:2008-12 DIN EN 61010-1:2011-07 DIN EN 60204-1:2011-01 DIN EN 61000-6-2:2006-03 DIN EN 61000-6-4:2011-09
- if the unit is equipped with WTMplus:	DIN EN 55011:2011-04 DIN EN 62311:2008-9

Martin Christ Gefriertrocknungsanlagen GmbH

An der Unteren Söse 50
37520 Osterode
Germany

Authorised representative
for CE matters:
S. Krippendorff

Osterode, 18/02/2016



M. Christ, Management

11 Appendix

11.3 EC declaration of conformity in accordance with the Pressure Equipment Directive



EC – DECLARATION OF CONFORMITY

in accordance with the EC Pressure Equipment Directive 2014/68/EU

The refrigeration units in freeze-dryers which are listed hereinafter were developed, designed, and manufactured in accordance with the relevant, fundamental safety and health requirements of the listed EC directives and standards.

In the event of modifications that were not authorised by us or if the product is used in a manner that is not in line with the intended purpose, this declaration will be rendered void.

<i>Product name:</i>	Refrigeration unit in a freeze-dryer
<i>Relevant unit types:</i>	All laboratory systems of the following types: Alpha, Beta, Gamma, Delta Pilot systems of the following types: Epsilon 1-4, Epsilon 2-4 Epsilon 2-6D, Epsilon 2-10D
<i>Max. permissible pressure:</i>	25 bar
<i>Max. permissible temperature:</i>	120°C
<i>Directives:</i>	2014/68/EU Pressure Equipment Directive
<i>Underlying standards:</i>	AD 2000 EN 378
<i>Applied conformity assessment procedures:</i>	Module A Category I

Martin Christ Gefriertrocknungsanlagen GmbH

An der Unteren Söse 50
37520 Osterode
Germany

Authorised representative
for CE matters:
S. Krippendorff

Osterode, 23/08/2016



F. Harms, Management

11 Appendix

11.4 Table of the sublimation pressure curve

°C	= mbar	°C	= mbar	°C	= mbar	°C	= mbar
28	37.79	1	6.57	-26	0.57	-53	0.025
27	35.64	0	6.11	-27	0.52	-54	0.024
26	33.60	-1	5.62	-28	0.47	-55	0.021
25	31.66	-2	5.17	-29	0.42	-56	0.018
24	29.83	-3	4.76	-30	0.37	-57	0.016
23	28.08	-4	4.37	-31	0.34	-58	0.014
22	26.43	-5	4.02	-32	0.31	-59	0.012
21	24.86	-6	3.69	-33	0.28	-60	0.011
20	23.37	-7	3.39	-34	0.25	-61	0.009
19	21.96	-8	3.01	-35	0.22	-62	0.008
18	20.63	-9	2.84	-36	0.20	-63	0.007
17	19.37	-10	2.56	-37	0.18	-64	0.006
16	18.17	-11	2.38	-38	0.16	-65	0.0054
15	17.05	-12	2.17	-39	0.14	-66	0.0047
14	15.98	-13	1.98	-40	0.12	-67	0.0041
13	14.97	-14	1.81	-41	0.11	-68	0.0035
12	14.02	-15	1.65	-42	0.10	-69	0.0030
11	13.12	-16	1.51	-43	0.09	-70	0.0026
10	12.27	-17	1.37	-44	0.08	-71	0.0023
9	11.47	-18	1.25	-45	0.07	-72	0.0019
8	10.72	-19	1.14	-46	0.06	-73	0.0017
7	10.01	-20	1.03	-47	0.055	-74	0.0014
6	9.35	-21	0.94	-48	0.050	-75	0.0012
5	8.72	-22	0.85	-49	0.045	-76	0.0010
4	8.13	-23	0.77	-50	0.040	-77	
3	7.58	-24	0.70	-51	0.035	-78	
2	7.06	-25	0.63	-52	0.030	-79	

11 Appendix

12 Glossary

Aeration, stoppering, storage

"Aeration, stoppering, storage" means automated sealing of the product vials with previously inserted rubber stoppers under partial vacuum and subsequent storage on the shelves at defined conditions as an integral part of a freeze-drying program. This is why this option can only be used in combination with a programmer module and if the freeze-dryer is equipped with an automatic aeration valve and a hydraulic shelf movement system.

Comparative pressure measurement

During the → *sublimation*, i.e. when the concentration of water vapour molecules is rather high in the atmosphere, the value that is provided by the gas-type dependent vacuum sensor of the "Pirani" type (e.g. Thyracont VCP 63) deviates from the value that is provided by a capacitive vacuum sensor (e.g. MKS 722B). When the proportion of water vapour molecules decreases towards the end of the main drying phase, the two sensors fall increasingly in line with one another.

The comparative pressure measurement is often used as a criterion for the automatic switching from the main drying phase to the final drying phase as well as for identifying the end of the process.

Desorption

Desorption (from Latin de-sorbere, sorbere = sup up, suck in) describes a phenomenon whereby molecules are released from the surface of a solid. In order to be able to desorb, the particle must have, or be provided with, a sufficient amount of energy in order to overcome the binding energy.

Double-chamber method

Freezing and drying of the product on several temperature controlled shelves inside a separated drying chamber is referred to as a double-chamber system. The advantage compared to the → *single-chamber method* is the considerably higher product capacity. In addition, the product chamber can be isolated from the ice condenser chamber by an intermediate valve in order to perform a so-called → *pressure increase test* for determining the end of the drying process.

Eutectic point

The eutectic point is the point at which a homogenous mixture (e.g. an eutectic alloy) passes directly from the liquid to the solid phase without the formation of a crystal mixture that consists of different phases.

Leakage test

The leakage test enables the chamber of the freeze-dryer to be tested for tightness in view of any gaseous or liquid media. Since absolutely tight components simply do not exist, a leak rate is determined. The parameters for the leakage test have been developed by Martin Christ Gefriertrocknungsanlagen GmbH specifically for freeze-dryers. In a first step, these parameters (vacuum, ice condenser temperature) must be reached. It is not until the conditions are fulfilled that the pressure control valve closes. Then, the actual leakage test is performed in a second step. The leak rate that is

12 Glossary

calculated after the end of the test provides information concerning the tightness of the system.

Pressure increase test

The pressure increase test can only be carried out with → *double-chamber method*. During the pressure increase test, the intermediate valve prevents the flow of steam from the drying chamber to the ice condenser so that the water vapour of the → *sublimation* cannot flow off. The result is a more or less distinct pressure increase that is measured in the product chamber. When the product has been completely dried, the vacuum does not decrease at all or only to a slight extent.

The pressure increase test is often used as a criterion for the automatic switching from the main drying phase to the final drying phase as well as for identifying the end of the process.

Reference designator

During the service life of industrial systems, a standardised reference designation system is required for the planning, design, realisation, maintenance, and disassembly stages in order to be able at all times to identify every single component within the system in an unambiguous manner. The reference designators are affixed to the components and entered into the technical documentation (e.g. circuit diagrams).

Safety pressure

Since the vacuum has a dominating influence on the product temperature, Martin Christ Gefriertrocknungsanlagen GmbH has integrated a so-called safety pressure feature into the freeze-dryers in order to ensure the protection of the product. If the pressure inside the drying chamber increases too strongly so that it exceeds the safety limit, the energy supply of the shelves will be interrupted and the → *sublimation* process slows down. This prevents the product from melting.

The safety pressure value that is entered should correspond to a temperature value that is 5°C below the melting point of the product on the vapour pressure curve above ice.

Single-chamber method

At the single-chamber method, the freezing as well as the subsequent drying of the product are both performed on several temperature controlled shelves inside the ice condenser chamber.

Sublimation

Sublimation (from Latin "sublimis" = high up in the air, raised), is a thermodynamic process of the direct transition of a substance from the solid phase to the gas phase.

13 Index

A

Access protection..... 82
Accessories 13, 41, 117, 126
Accident prevention 28, 29
Accident prevention regulations 27
Accidents 39
Acids..... 11, 40
Acids (hazards)..... 34
Actual values of the current process 63
Additions 40
Administration 80
Adsorption filter..... 54
Aeration 48
Aeration (connection)..... 133
Aeration medium, preselection..... 77, 109
Aeration valve, cleaning and care 121
Aeration valve, malfunction 114
Aeration, stoppering, storage ... 102, 108, 143
Ambient conditions..... 134
Ambient temperature 46, 134
Apparent power 19, 133
Automatic aeration, stoppering, storage... 108
Azides..... 11
Azides (hazards)..... 35

B

Beeper 81
Behaviour of the pressure control valve in the case of insufficient ice condenser cooling 82
Burns 39
Button "Set values: view/edit" 63
Button "Standard unit test" 69
Button "Stop" 74

C

Calculation of the control set value and of the gradient for the temperature 135
Calculation of the control set value for the vacuum 135
Capacity test -30°C 72
Capacity test -50°C 72

CE mark in compliance with the directive 2006/42/EC 25
Changing of operating supplies..... 40
Changing the distance between the shelves 59
Chemical burns..... 39
Chemical reactions 126
Circuit diagram..... 134
Cleaning 40
Cleaning agents 117, 126
Cleaning the accessories 117
Cleaning the freeze-dryer..... 117
Click on touch 82
Commissioning 13
Comparative pressure measurement 100, 109, 143
Compatibility test..... 27
Compliance with the EC health and safety directives 27
Condensate, contaminated (hazards) 49, 114, 121
Condensate, contaminated (hazards) 35, 119
Conditions for switching to the next section 95
Configuration of sensors 84
Connection..... 41, 47
Connection (hazards)..... 30, 46
Connection requirements 133
Contaminated condensate (hazards) 35, 49, 114, 119, 121
Contaminated defrosting water (hazards) 35, 49, 114, 119, 121
Control switch 38
Control system type 90
Conversions..... 40
Cooling system 134
Cooling water feed flow connection..... 133
Cooling water flow controller 133
Cooling water pressure 133
Cooling water return flow connection 133
Copying a program 106
Copyright 12
Corrosion 117, 126

Index

Cost estimate	130	Door contact switch.....	38
Cracks	126	Double-chamber method.....	143
Creating a blank program.....	97	Drain (standard, connection)	133
Creating a program	97	Drain at the connector block (special equipment)	133
Customer-provided fuses	47	Drying cartridge	54
D		Drying chamber, cleaning and care.....	119
Damage to the materials of construction ..	117	E	
Dangerous materials.....	126	EC declaration of conformity (Machinery Directive)	13, 137
Data interface (LAN)	133	EC declaration of conformity (Pressure Equipment Directive)	13, 139
Date/Time	80	Editing a program.....	105
Declaration of conformity (Machinery Directive)	13, 137	Electrical connection	133
Declaration of conformity (Pressure Equipment Directive)	13, 139	Electrical system (maintenance)	122
Declaration of decontamination.....	130	Electricity (hazards)	31, 47, 122
Decontamination agents	126	Emergency.....	39
Decontamination with hydrogen peroxide (H ₂ O ₂).....	11, 27, 28	End of drying and aeration	24
Defrosting	24	Entering set values in the manual mode	91
Defrosting water, contaminated (hazards). 35, 49, 114, 119, 121		Environmental protection	29
Defrosting with hot gas.....	24	Equipment connections.....	133
Deleting a program	107	Error correction	111
delta p pressure increase test (option)	95	Eutectic point	143
deltaT comparative	95	Exhaust gases (hazards)	36, 51
deltaT product.....	95	Explanation of symbols	13
deltaT shelf	95	Explanation of the symbols and notes.....	26
Desorption	143	Explosive substances	35
Details		External data storage device.....	63
Process and equipment messages	68	F	
Details concerning the software version.....	90	Failure memory	87
Device options	83	Filling quantity	132
Dialog box "New program"	75	Film "Radiation Shield"	57, 119
Dialog box "Operating mode: select/start" ..	69	Film "Solvent Shield".....	57, 119
Dialog box "Process and equipment messages".....	67	Film on the loading door (cleaning)	119
Dialog box "Schematic system diagram"	66	Final drying	24
Dialog box "Tools".....	64	Fire	39
Dimensions	43	Fire prevention.....	41
Direct hazard to the life and health.....	26	Form for the return of defective parts	130
Disinfectants	126	Freeze-dryer type.....	90
Disinfection of the drying chamber and accessories	126	Freeze-dryer, cleaning and care	118
Displayed vacuum value is not correct	111	Freeze-drying of acid-containing products..	11
Disposal of the freeze-dryer	131	Freeze-drying of azide-containing products	11
Disposal of the packaging	131	Freeze-drying of solvent-containing products	10, 28

Freeze-drying of solvents (special equipment)	28	Hazards (transport)	29, 43, 44
Freeze-drying phases	22	Hazards (vacuum pump exhaust gases)	36, 51
Freeze-drying process	22	Hazards (vacuum pump oil)	36, 123
Freeze-drying with the PGMplus programmer module	93	Health and safety rules and regulations and regulations for the prevention of accidents	27
Freezing	23	Heat dissipated by cooling water	133
Functional and operating elements	14	Heat emission	132
Further applicable documents	9	Heat exchanger	122
G		Heat transfer medium	132
Gas injection with a proportional valve	78, 108	Heat transfer medium system (maintenance)	125
General conditions	12	Hot-gas defrosting	24
General information on freeze-drying	20	Humidity	134
General malfunctions	111	Hydraulic (Shelves and Intermediate Valve)	57
General tasks (maintenance)	117	Hydraulic system (hazards)	32, 125
H		Hydrogen peroxide (decontamination)	11
H ₂ O ₂ (decontamination)	11	I	
H ₂ O ₂ decontamination system (special equipment)	27, 28	Ice condenser	132
Handling hazardous materials	42	Ice condenser chamber, cleaning and care	119
Hazard warnings	9, 12	Ice condenser temperature	95
Hazardous materials, handling	42	Importance of the operating manual	9
Hazards	39	Important information	26
Hazards (acids)	34	Improved cooling rate (fast freezing)	108
Hazards (azides)	35	Inertisation	79, 108
Hazards (connection)	30, 46	Infectious substances	126
Hazards (contaminated condensate)	35, 49, 114, 119, 121	Informal safety notes	29
Hazards (contaminated defrosting water)	35, 49, 114, 119, 121	Initial start-up	55
Hazards (electricity)	31, 47, 122	Initial start-up (hazards)	30, 55
Hazards (general, transport to commissioning)	29	Injuries	39
Hazards (general, transport)	43, 44	Inspection by the manufacturer	129
Hazards (hydraulic system)	32, 125	Installation of accessories	55
Hazards (initial start-up)	30, 55	Installation site	46
Hazards (loading door)	36	Installing/changing the stepped plates	59
Hazards (nitrogen)	33	Insufficient ice condenser or shelf temperature	112
Hazards (products, harmful)	34, 118	Insufficient ice condenser temperature	115
Hazards (refrigeration system)	31, 124	Insufficient vacuum	111, 113
Hazards (set-up)	30, 46	Intended use	9
Hazards (shelves)	37, 57	Intermediate Valve	57
Hazards (solvents)	34	IP protection category	133
Hazards (surfaces, cold)	37	L	
Hazards (surfaces, hot)	37, 118, 123	Language	76

Index

Layout of the freeze-dryer	14	Measures to be taken to ensure safe operation	41
Leakage in the media drain valve.....	111	Media drain valve.....	49
Leakage test	71, 143	Media drain valve, cleaning and care	121
Line disconnecter.....	38	Media drain valve, malfunction.....	114
Loading a program.....	106	Mode of operation	20
Loading door (film)	119	N	
Loading door (hazards)	36	Name plate	47
Loading door (operation).....	56	Network	81
LPCplus SCADA system.....	110	Network drive.....	63
LSCplus control system	61	New program	75
Lyes	40	Nitrogen (hazards)	33
LyoBalance weighing system.....	66, 109	No indication on the display	111
LyoControl measuring system.....	110	Noise level	132
LyoControl-Rx.....	95	Nominal current	133
LyoLogplus data logging software	110	Nominal voltage	19
M		Notes on safety and hazards	9
Main drying	23	Notes on transport	44
Main switch (line disconnecter)	38	O	
Main window "?".....	90	On-site transport	45
Main window "Manual"	62	Operating elements.....	14
Main window "Options"	76	Operating hours	87
Main window "Program"	75	Operating mode: select/start	69
Mains fuse	133	Operating personnel	27, 28
Mains input	133	Operating status	63
Mains voltage.....	134	Operating voltage.....	47
Maintenance	40, 87, 89	Operation	41
Maintenance (electrical system).....	122	Operational safety.....	126
Maintenance (general tasks).....	117	Option: Aeration, stoppering, storage.....	102
Maintenance (heat transfer medium system)	125	Option: Comparative pressure measurement	100
Maintenance (refrigeration system).....	124	Option: cooling water flow controller.....	133
Maintenance (vacuum sensor)	125	Option: LyoBalance weighing system.....	66
Maintenance (vacuum system)	123	Option: Pressure increase test.....	65, 99
Maintenance and service	117	Option: USB process recording.....	65
Maintenance performed by the user.....	117	Option: Weighing system	102
Maintenance schedule	127	Optional extensions	108
Malfunction of the pressure control valve .	114	P	
Malfunctions.....	111	Packaging.....	131
Manual freeze-drying	90	Part number	19, 132
Manufacturer.....	117, 126, 131, 132	Password input fails	111
Manufacturer contact data	90	Password operator/ maintenance/ administrator	83
Marking of the unit	25	Password timer runtime	82
Materials of construction, damage	117		
Mathematical relations	135		
Max. humidity.....	134		

Pathogenic substances	118, 126	Return of defective parts	129
Performance data	132	Risk assessment.....	27
Performance test.....	70	S	
Physical data	132	Safe operation	41
Pilot and production systems, unit test	70	Safety and hazard notes	29
Potential hazard to the life and health	26	Safety area	41
Potentially hazardous situation.....	26	Safety data sheets	134
Power failure.....	112	Safety devices	38
Power supply	47	Safety distance	46
Precision control needle valve for air injection	48	Safety instructions.....	9, 12
Preparation	22, 55	Safety notes concerning set-up and connection.....	29
Preselection of the aeration medium ..	77, 109	Safety notes concerning the initial start-up.	29
Pressure control valve	52	Safety notes concerning the operation	31
Pressure control valve, malfunction	114	Safety notes concerning the transport.....	29
Pressure increase test	65, 99, 108, 144	Safety pressure.....	144
Pressure marks.....	126	Safety-conscious work	27
Pressure measurement, comparative.....	109	Schematic system diagram	66
Prevention of accidents.....	9	Scope of supply	13
Process and equipment messages	67	Sensor adjustment	89
Process and error messages	115	Serial number	19, 90, 116, 129
Process data.....	62	Service.....	129
Product residues.....	118	Service contact	116
Product temperature measurement system WTMplus.....	109	Service life	117
Products containing acids	11	Service work	129
Products containing azides	11	Set process values.....	63
Products, harmful (hazards).....	34, 118	Set-up.....	41
Program list.....	75	Set-up (hazards).....	30, 46
Program sections.....	94	Set-up and connection	46
Program templates.....	105	Shelf cooling test.....	73
Protection class	133	Shelf distance (change)	59
R		Shelf mapping test	74
Radiation Shield film	57, 119	Shelf Movement.....	57
Radioactive substances	118	Shelf movement system, two-hand control.	38
Rated current	19	Shelves.....	57
Reference designator.....	66, 68, 87, 144	Shelves (hazards).....	37, 57
Refrigerant data	19	Signs of corrosion	126
Refrigeration problems		Single-chamber method	144
Conditions at the location of use	46	Small flange connections	113
Refrigeration system	132	Solvent Shield film	57, 119
Refrigeration system (hazards).....	31, 124	Solvent-containing products.....	10
Refrigeration system (maintenance).....	124	Solvents.....	40
Remaining hazards.....	42	Solvents (hazards).....	34
Responsibility of the operator.....	27	Solvents.....	117
		Special equipment	108

Index

Special equipment – H ₂ O ₂ decontamination system.....	27, 28	Transport	43
Special equipment for freeze-drying applications involving solvents.....	28	Transport (hazards)	29, 43, 44
Special equipment: Door contact switches.	38	Transport (hazards, general).....	43, 44
Special equipment: drain at the connector block.....	133	Transport safety devices	45
Special equipment: Gas injection with a proportional valve	78	Transport to commissioning (hazards, general)	29
Special equipment: Inertisation	79	Two-hand control, shelf movement system	38
Special equipment: Precision control needle valve for air injection.....	48	Type.....	19, 132
Special equipment: Preselection of the aeration medium.....	77	U	
Special equipment: Solvent Shield film	57	Unit of measurement.....	77
Special equipment: Stainless steel door latch at the loading door.....	120	Unit test of pilot and production systems....	70
Special equipment: water cooling system	133	Unpacking the freeze-dryer	43
Specialist personnel.....	114, 129, 130	USB process recording	65, 109
Stainless steel door latch at the loading door	120	User interface	61
Standard unit test.....	69	UV radiation	47, 117
Standards and regulations	13	V	
Status line	63	Vacuum	95
Stepped plates (installation/change)	59	Vacuum connection	133
Storage	43	Vacuum pump.....	51
Storage and transport	43	Vacuum pump exhaust gases (hazards)	36, 51
Storage conditions	43	Vacuum pump is not activated	112
Stress-corrosion.....	126	Vacuum pump oil (hazards)	36, 123
Sublimation	144	Vacuum pump oil change.....	88
Supply voltage	47	Vacuum pump warm-up	96
Surfaces, cold (hazards)	37	Vacuum sensor.....	53, 114
Surfaces, hot (hazards).....	37, 118, 123	Vacuum sensor (maintenance)	125
Switching the freeze-dryer OFF	110	Vacuum system (maintenance).....	123
System properties	81	Vapour pressure curve above ice.....	64
T		Vapour pressure curve for ice and water....	21
Table of the sublimation pressure curve... 141		Ventilation	46, 115
Technical data	132	Viewing or editing the set values.....	92
Technical documentation	134	Volumetric flow rate	133
Temperature of water feed flow.....	133	W	
Temperature of water return flow	133	Warranty and liability.....	12
Thermal stress	46, 117	Water feed flow temperature.....	133
Tools.....	64	Water return flow temperature.....	133
Topping-up of operating supplies	40	Water temperature difference	133
Touchpanel does not react.....	111	Weighing system.....	102
Toxic substances	118	Weighing system LyoBalance	66, 109
		Weight	43, 132
		Wireless product temperature measurement system WTMplus.....	109
		WTMplus configuration	86

WTMplus wireless product temperature
measurement system 109

Y

Year of manufacture 19